

Automate Motor Programming Guide



Ver. 3

| 1. ASSEMBLY |
|--|
| Please refer to separate Rollease Acmeda System Assembly Manual for full assembly instructions relevant to the hardware system being used. |
| 2. BATTERY MANAGEMENT |
| For battery motors; Prevent discharging the battery completely for extended periods, recharge as soon as the battery is discharged |
| CHARGING NOTES Before first use please charge motor for 6-16 hours, using the recommended AC charger |
| During operation, if battery is low, the motor will beep 10 times to prompt the user it needs charging. |
| 3. PRODUCT RANGE |
| The Quick Start Programming Guide is universal for all Automate Motors including: |
| Internal Tubular Large Tubular |

| 3. PRODUCT RANGE (cont.) |
|---|
| 0.6 Cord Lift |
| |
| 0.8 Cord Lift |
| |
| Curtain |
| |
| Tilt Motor |
| |
| Note: Curtain motor does not Jog but instead LED flashes. DC motor does not beep. |
| DISPOSAL AND RECYCLING |
| Do not dispose of in general waste. |

| INSTALLER BEST PRACTICE AND TIPS |
|--|
| SLEEP MODE |
| If pre-programmed: before shipping the motor ensure the motor is put into sleep mode so it doesn't activate during transit. |
| LOCK REMOTE |
| Prevent users accidentally changing the limit; ensure the remote is locked as your last step of programming. |
| ZONE / GROUPS |
| Ask the customer the day before to think how shades will be zoned on the remote. This may save an extra call out. |
| SETTLE FABRIC |
| Run the fabric up and down several times to ensure fabric has settled to some extent and re adjust the limits if needed. |
| CHARGE 100% |
| For battery motors ensure the motor is fully charged as per instructions. |
| INSTALLERS REMOTE |
| Use a spare remote to individually program each shade. Then use that remote to group rooms as per the user's needs. If you go back and service the installation later then, that same remote can be used to check the individual shades. |

| P1 LOCATIONS |
|------------------|
| |
| Internal Tubular |
| |
| 0.6 Cord Lift |
| |
| Curtain |
| |
| Large Tubular |

| CAUTION |
|---|
| This device complies with Part 15 of the FCC Rules / Innovation, Science and Economic Development Canada's licence-exempt RSS(s). Operation is subject to the following two conditions: (1) this device may not cause harmful interference. (2) this device must accept any interference received, including interference that may cause undesired operation. |
| L'émetteur/récepteur exempt de licence contenu dans le présent appareil est conforme aux CNR d'Innovation, Sciences et Développement économique Canada applicables aux appareils radio exempts de licence. L'exploitation est autorisée aux deux conditions suivantes : 1. L'appareil ne doit pas produire de brouillage; 2. L'appareil doit accepter tout brouillage radioélectrique subi, même si le brouillage est susceptible d'en compromettre le fonctionnement. |
| Changes or modifications not expressly approved by the party responsible for compliance could void the user's authority to operate the equipment. |
| This equipment has been tested and found to comply with the limits for a Class B digital device, pursuant to part 15 of the FCC Rules. These limits are designed to provide reasonable protection against harmful interference in a residential installation. This equipment generates uses and can radiate radio frequency energy and, if not installed and used in accordance with the instructions, may cause harmful interference to radio communications. However, there is no guarantee that interference will not occur in a particular installation. If this equipment does cause harmful interference to radio or television reception, which can be determined by turning the equipment off and on, the user is encouraged to try to correct the interference by one or more of the following measures: |
| SAFETY |
| WARNING: Important safety instructions to be read before installation and use. Incorrect installation or use can lead to serious injury and will void manufacturer's liability and warranty. It is important for the safety of persons to follow the enclosed instructions. Save these instructions for future reference. |
| <ul style="list-style-type: none"> Do not expose to water, moisture, humid and damp environments or extreme temperatures. Persons (including children) with reduced physical, sensory or mental capabilities, or lack of experience and knowledge, should not be allowed to use this product. Use or modification outside the scope of this instruction manual will void warranty. Installation and programming to be performed by a suitably qualified installer. Follow installation instructions. For use with motorized shading devices. Keep away from children. Frequently inspect for improper operation. Do not use if repair or adjustment is necessary. Keep clear when in operation. Replace battery with correctly specified type. |
| <ul style="list-style-type: none"> Reorient or relocate the receiving antenna. Increase the separation between the equipment and receiver. Connect the equipment into an outlet on a circuit different from that to which the receiver is connected. Consult the dealer or an experienced radio/TV technician for help. |

INSTALLER QUICK START PROGRAMMING

STEP 1 ON REMOTE

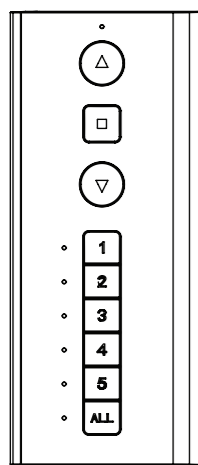

Select a single or multiple channels by toggling channels as required. Note the corresponding LED next to each channel.

STEP 2

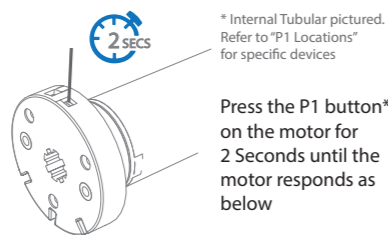

Within 4 seconds hold the stop button on the remote for 3 seconds. The motor will respond with 2 x Jogs and 3 x Beeps



STEP 3 CHECK DIRECTION

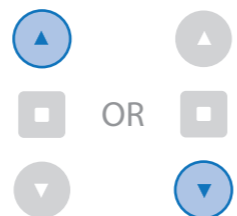

Press up or down to check the motor direction. If correct skip to step 5.

STEP 4 CHANGE DIRECTION

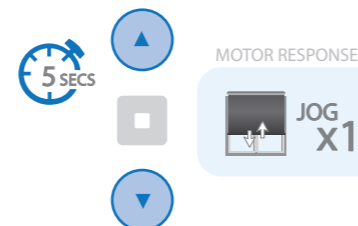

If the shade direction needs to be reversed; press and hold the up & down arrow together for 5 seconds until the motor Jogs.

Reversing motor direction using this method is only possible during initial set-up.

This setup wizard should be used for new installation or factory reset motors only. Individual steps may not work if you haven't followed the wizard from the beginning.

STEP 5 SET UPPER LIMIT



Move shade to desired top limit by pressing the up arrow repeatedly. Then press and hold up & stop together for 5 sec to save limit.



Tap the arrow several times or hold down if needed; press arrow to stop.

STEP 6 SET BOTTOM LIMIT

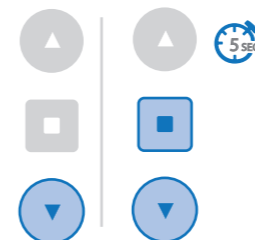

Move shade to desired bottom limit by pressing the down arrow repeatedly. Then press and hold down & stop together for 5 sec to save limit.

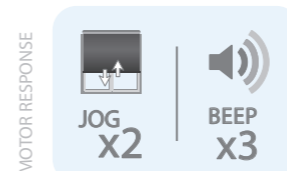

Tap the arrow several times or hold down if needed; press arrow to stop.

STEP 7 SAVE YOUR LIMIT

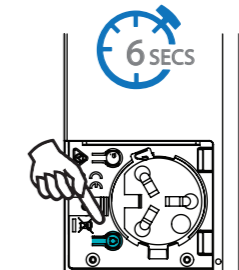

Repeat steps 1-6 for all motors. Once complete Press and hold the Lock button for 6 seconds while looking at the LED, and hold until solid.

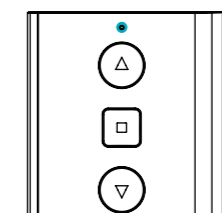

FACTORY RESET MOTOR RESET PROCEDURE

To reset all settings in the motor press and hold the P1 Button for 14 seconds, you should see 4 independent jogs followed by 4x Beeps at the end.

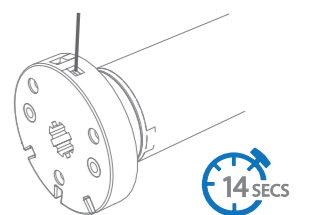

* Internal Tubular pictured above. Refer to "P1 Locations" for specific devices

MOTOR RESPONSE

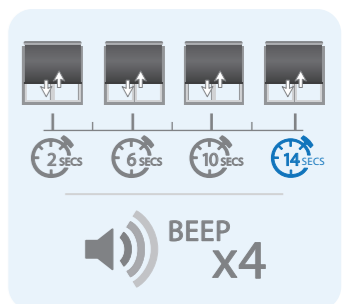



USER GUIDE

QUICK START GUIDE

BUTTON OVERVIEW

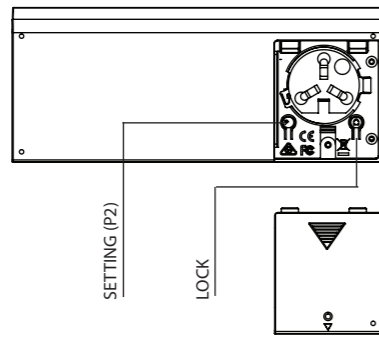
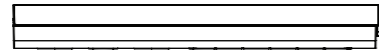
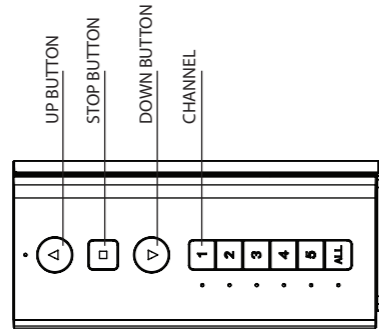

REPLACE BATTERY

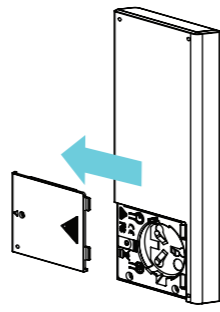

Remove cover from remote; unscrew with screw driver then firmly press down and slide left.

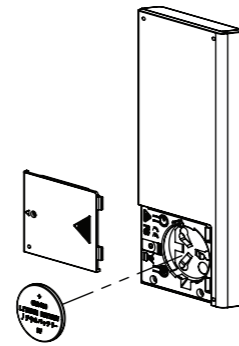

Install battery CR2430 with positive (+) side facing up.

WALL MOUNTING

Use supplied fasteners and anchors to attach the base to wall.

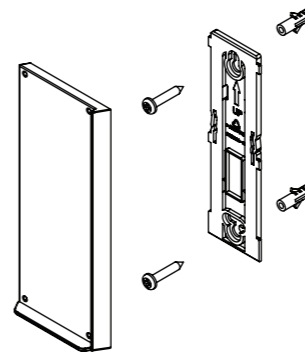

Replace cover by pressing snap latches into place.

GROUP CONTROL

Channel "ALL" is pre-set to control ALL shades paired to your Multi-channel remote.

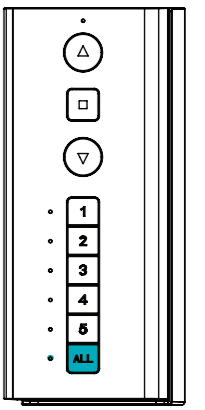

SELECTING A CHANNEL

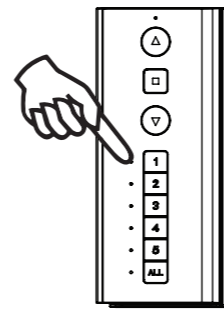

Press any ch to see previously selected channels. The last selected channel will remain in memory. To un-select a channel press the same channel and select any new channels.

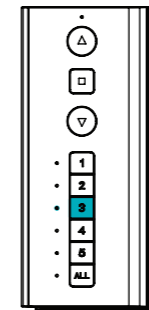

CONTROL SHADE UP OR DOWN

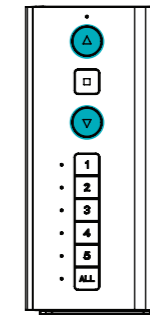

While the channel is displayed press up or down to move shade accordingly

STOPPING THE SHADE

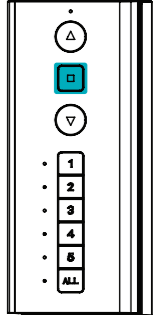

Press the stop button to stop shade at any point

USER GUIDE

ADVANCED PROGRAMMING

DISABLE LIMIT SETTING

This mode is intended to be used after all shade programming is completed. User Mode will prevent accidental or unintended changing of limits.

Push switch to lock or unlocked position

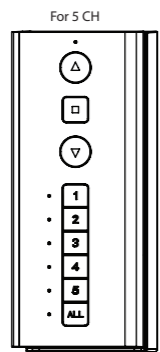
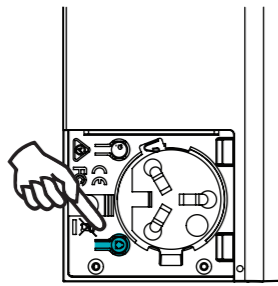

LED solid on when locked
LED blinking when unlocked

Pressing the lock button for 6 second will toggle between locked and unlocked LED show Solid or flashing

SET A FAVORITE POSITION

Move shade to desired position by pressing UP or DOWN on the remote.

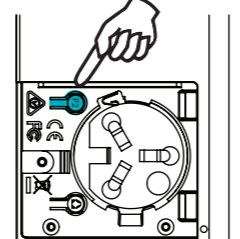
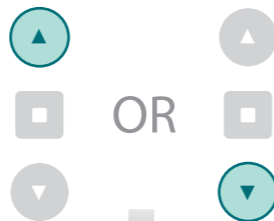

MOTOR RESPONSE



MOTOR RESPONSE



Press STOP on controller

MOTOR RESPONSE



Press STOP on controller

CREATE CUSTOM GROUPS

It is possible to copy one channel to another channel to create custom groups

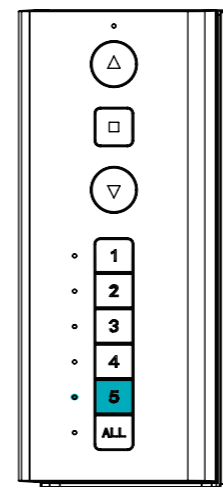

STEP 1.

EXISTING REMOTE
Select the channel you want to transfer

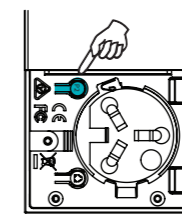

Press P2 Button on existing remote.

MOTOR RESPONSE



MOTOR RESPONSE



Press P2 Button again on existing remote.

Next step to be completed within 4 seconds of Step 1

STEP 2.

NEW REMOTE
Select the channel you want to transfer too

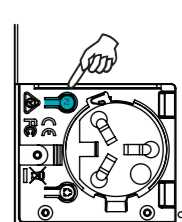
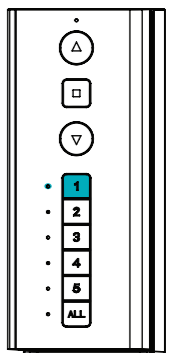

Press P2 Button on new remote.

MOTOR RESPONSE

