



CACO, INC.
WINDOW FASHIONS

Retail Price Guide 2024

Serenity Roller Shades

Cordless Horizontal Blinds

Delta Woods

Avalon Faux Wood

Cordless Fast Faux

Cordless Aluminum Horizontal Blinds

1" Mini

2" Maxi

1/2" Micro

Designer Natural Woven Woods

Boone Collection Cellular Shades

Dual Sheer Shades

Sheerview Horizontal Shade Collection

Table of Contents

Customer Service Polices	1-2
Serenity Roller Shades	
Features, Options, Care & Operating Instructions	3
Pricing	4-7
Motorization	8-9
Warranty	10
Horizontal Blinds	
▪ Delta Woods	
Price Charts, Features & Options	11
Motorization	12
Warranty	13
▪ Avalon Faux Wood	
Price Charts	14
Features & Options	15
Warranty	16
▪ Cordless Fast Faux	
Price Charts, Features & Options	17
Warranty	18
▪ Aluminum Horizontal Blinds	
Available Colors and Limitations	19-20
1" Standard Cordless	21
1" Premium Cordless	22
1" Motorized	23
2" Cordless	24
1/2" Micro Cordless	24
Warranty	25
Designer Natural Woven Woods	
Styles & Features	26
Measuring & Headrail Options	27
Shade Option & Limitation Charts	28
Features & Surcharges	29
Motorization	30
Pattern Identification	31-32
Cordless Limitations	33
Woven Wood Shade Pricing	
▪ Dynasty Collection Charts	34
▪ Galaxy Collection Charts	35
Special Notes & Ordering Instructions	36
Warranty, Care & Maintenance	37



Table of Contents

Boone Collection Cellular Shades	
Features & Benefits	38
Style Options	39
Headrail and Stacking Charts	40
Standard Features, Surcharges & Limitations	41
Fabric Selections & Coordination	42-43
Color Availability	44
Fabric Price Group Charts	45
Price Charts	46-49
Motorization	
Simple Touch	50
Automate	51
Special Shades	
Slider Cellular Shades	52
Arches	52
Specialty Shapes	52
Simply Cordless Systems	53
Warranty	54
Dual Sheer Shades	
Features	55
Cassette Options	56
Bottom Bar Options	57
Specifiactions	58
Fabric Reference	59-60
Control Options	
Clutch & Wand Control	61
Remote Control	62
Price Charts	63-64
Warranty	65
Sheerview Horizontal Shade Collection	
Features, Benefits Fabric Reference & Measuring Instructions	66
Design and Operation	67
Fabric Selection	68
Price Charts	69-71
Operating Systems, Options & Motorization Surcharges	72
Child Safety, Care & Warranty	73



How to place an order

For your convenience, CACO provides you with the option of placing orders by either telephone, email, online or fax (if placed by fax, CACO will provide order forms at no additional cost; customers must request forms). Orders placed after 3:00 pm EST will be forwarded to the next business day.

Telephone orders

CACO Customer Service Representatives are available between the hours of 8:30 am and 5:00 pm Eastern Standard time at **1-800-552-5278**. Any order placed by phone requires a signed order confirmation returned to customer service by fax or email before proceeding with order. Keep in mind, when phoning in your order, it is important to have the following information available:

- Account number (if known)
- Individuals name that is calling
- P.O. number and/or side mark
- Color or colors
- Type of product ordered
- Measurements (width-first, length-second)
- Inside or outside mount (i.m./i.b or o.m./o.b)
- Control instructions
- Ship to address if different than sold-to
- Special instructions for shipping
- Valance instructions
- Any other special instructions
- Quote number, if order is placed from a previous quote

Fax and Email Orders

Fax orders can be placed any time of day or night including holidays at **1-866-926-5836** or email to customerservice@cacoinc.com. To ensure order accuracy for faxed orders, it is advisable to use the order forms CACO supplies or a comparable form. It is important to note the number of pages of your order, including the cover sheet to ensure that no pages will be missing. For fax or email orders please include all of the same information required for telephone orders. Any omission of pertinent information will only delay your orders manufacturing time.

Online Orders

Orders can be placed online at <https://88043.picbusiness.com/>. If you your account has not been set up to access our online portal, please contact support@cacoinc.com to sign up. This access allows you to quote, order as well as make payments online. Please note roller shades, aluminum blinds and shutters are not available online to quote or place as orders, you will need to contact customer service to for information about these products. Additionally, orders are released from internet hold and reviewed for credit at the daily 3:00 PM EST cutoff. Any orders submitted online after this time will be reviewed the following business day.

How to expedite an order

We can often provide a faster ship date for emergency situations, only if this is noted at the time the order is placed. Requested next day and second day shipping will move freight prepaid and will be added to your account at the time of invoicing.

Expedite cost

48-hour rush: \$7.50 per blind 72-hour rush: \$5.00 per blind

NOTE: Rush only applies to discounted orders, not on contract quotes and may not be available during high volume periods. The clock starts running after your order clears credit and enters production.

How to add on or make changes to an order

In the event that you wish to add to your original order, it is possible, as long as the order is still in production. You will be required to submit changes in writing and must be signed by a person of authority indicating the items you wish to add or change. No verbal requests can be made. You will need to refer to the original P.O. number and indicate clearly the additions or changes you're requesting. Note: because add-ons may affect production time, check with customer service for any possible delays.

How to cancel an order

Cancellations or changes require an immediate response and can only take place up until the start of fabrication. You must first identify your P.O. number or side mark and then state the cancellation or change. Cancellations must be faxed or emailed in writing only, phone calls are not permitted. If an order has already been cut, a minimum charge of 50% will apply.

Should you order for the same room at different times?

This is a frequently asked question and should be addressed and explained at the point of sale. Under normal circumstances blinds, shades and verticals should be ordered for the same room at one time to prevent color deviations, as a result of dye and paint color variations from original lot to the other. If additional blinds, shades or verticals are ordered at a later time for the same room there can be a distinct color difference from the existing product to the new product. Also, window coverings that have been previously installed can have shade differentiations from newer products due to the progress of aging.

Questions concerning an order

Once you contact customer service you must have your P.O. number and/or side mark available.

Shipping and Handling Charges

- A \$15 minimum order charge will be added to any order with only one item.
- A \$8 per blind handling fee will be added for all delivery orders.
- A \$10 per blind handling fee will be added to drop ship orders in lieu of the \$8 per blind fee.
- Any orders with a product over 90" width (width or length for verticals) will have an oversized fee of \$85 per blind up to \$170 added to the per blind fee.
- Any orders with a product over 104" (including width or length for verticals or valances that are not ordered spliced) will ship by LTL carrier F.O.B Johnson City, TN.
- Any order to be delivered by LTL truck to an area considered residential or restricted delivery areas by freight carriers will have an additional fee of \$125. The residential fee can be avoided if you opt to pick up shipment at the freight terminal in lieu of delivery. If you opt for terminal pick up, customer service will need to be informed at the time your order is placed.
- Accessorial LTL Truck delivery charges such as liftgate, inside delivery, re-consignment, re-delivery, etc. will be the responsibility of the receiving party.

Credit and additional charges

Open accounts are established by submitting a CACO credit application. You will be required to list trade and bank references as well as a current sales tax id number. C.O.D. accounts are also obligated to submit a credit application. Invoices are due within 30 days of the date posted. After 30 days accounts will be charged 1.5% interest per month. CACO reserves the right not to ship to accounts with past due balances.

Payment Policy

Current payment methods accepted are check, emailed or faxed checks for ACH processing, credit cards (Mastercard, Visa, Discover) and online payments by credit card or bank draft. Due to additional credit card fees, effective March 8th, a 2% processing fee will be added to all credit card payments. This fee can be avoided by either mailing checks to our PO Box or to expedite payments send a copy of your check along with our Check by Fax form by email to customerservice@cacoinc.com or fax to (866) 552-5278. Please note CACO will not automatically charge any credit card or process ACH transaction without a current, on file preauthorization forms, otherwise approval will be required at the time of each transaction.

If you receive product that has been visibly damaged while in transit

Before accepting any shipments, please examine each carton carefully. If shipment shows any signs of mistreatment or damage, i.e., wheel marks, crushed or bent cartons note this on the bill of lading and have the driver sign it and note damage. Should a replacement be necessary, CACO will bill you. Your replacement invoice will enable you to file a claim with the responsible carrier. It is imperative that you count all cartons prior to signing the bill of lading; any shortages must be noted on the bill of lading with the driver's signature.

Shipping discrepancies

If the product received does not agree with your packing slip, contact a CACO customer service representative within 24 hours. Your representative will verify any action needed for a resolution and expedite any necessary replacements.

If you should receive a defective product

Your warranty protects you against defective products (please read your warranty for all information, disclaimers and liabilities). Should you receive a defective product, contact CACO customer service and provide detailed information including your P.O. number. If the product is not sent back for repair, you will be invoiced for a replacement and required to return back the original product to CACO for inspection. Any issue arising past 30 days from receipt of original order will be required to return product for repair.

How to Measure

Inside mount

A. Measure the window opening at three different places and use the narrowest dimension when ordering. Be exact! The factory will make the blind slightly narrower, so it won't rub against the window casing. (See A inside mount).
 B. Measure the height of the window from the top (soffit) down to the sill. NOTE: The finished blind length may have a tolerance of based on product.

Outside mount

Measure exact width and height of the area to be covered. It is recommended that blinds overlap the window opening by at least 1 1/2" on each side to insure privacy and control sunlight. (See A outside mount). When installation is designed for "no sill," allow the blind to overlap the bottom of the window casing by at least 1 1/2". Blinds will be made to exact measurements given. NOTE: The finished blind length may have a tolerance of based on product.

Based on product, CACO will automatically make a deduction on width for measurements submitted as inside mount.

CACO will not make any deductions for measurements submitted as outside mount.

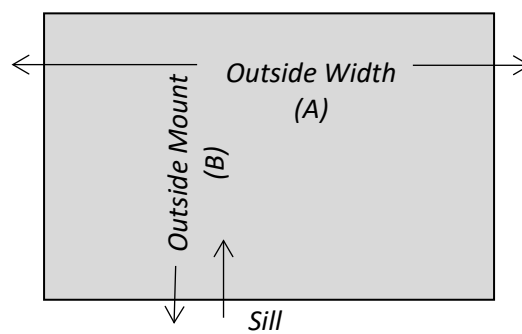
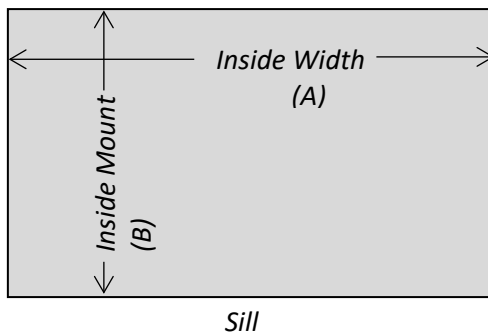

Features, Options & Care

Features

- Manual Clutch system operated via #10 stainless steel, plastic or painted steel bead chain.
- Varying diameters of aluminum tube to accommodate most any width.
- 1" aluminum internal hem bar.
- Available in many styles in Textstyle, Mermet decorative fabric and blackout fabrics. Fabric opaqueness varies from translucent to room darkening.
- Textstyle and Mermet solar shading fabrics can still keep the view while blocking harmful UV rays from the sun. Easy to clean.

Options

- 3" or 4" flat
- Rollease CD120, CD 110 or CD 100 Cassette System
- Rollease 5" Fascia Dual Shade System Colors available
- Fabric Wrapped Fascia available in 4" Fascia with skyline clutch only
- Aluminum external bottom bar Colors available
- Motorization, 12 volt DC or 110 volt AC with multiple control options. See motorized roller shade section

Options Color Availability					
	White	Alabaster	Aluminum	Bronze	Black
3" Fascia	Y	Y	Y	Y	Y
4" Fascia	Y	Y	Y	Y	Y
CD 100	Y	Y	Y	Y	Y
CD 110	Y	Y	Y	Y	Y
CD 120	Y	Y	Y	Y	Y
5" Fascia	Y	N	Y	Y	N
External Bottom Bar	Y	Y	Y	Y	Y

Surcharges

- External Clutch \$11.50 per shade
- Galaxy Clutch \$21.50 per shade
- Fabric Wrapped Fascia 25% upcharge on 4" fascia charge
- Side Channels* \$31.75 per ft (length of shade)
- Sill Channels* \$13 per ft (width of shade)

Customer discount will be applied to additional charges for Clutches, Side and Sill channels.

* Round up to nearest foot!

Cordless Options:

Minimum Width	Maximum Width	Maximum Length
12"	84"	96"

External Bottom Bar:

25"	31"	37"	43"	49"	55"	61"	67"	73"	79"	85"	97"	108"	120"
20	22	26	30	34	38	41	45	50	55	58	65	71	80

CARE AND OPERATION

Make sure brackets are mounted level or shade will roll crooked.

IF YOUR SHADE DOES NOT ROLL STRAIGHT, CORRECT AS FOLLOWS:

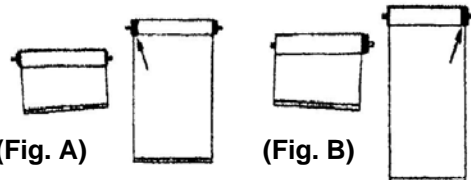

Example:

(Fig. A)

(Fig. B)

(Fig. A) - Shade veers toward right. Correct by lowering shade completely and place a piece of paper, indicated by arrow, as close to the roller as possible. It acts as a shim.

(Fig. B) - Shade veers toward left. Correct by lowering shade completely and place a piece of paper, indicated by arrow, as close to the roller as possible. It acts as a shim.

Fabric Style	Type	Width	Railroad	Chart
3000 Privacy	Screen	118"	N	4
3000 Net 1%	Screen	118"	N	4
3000 Net 3%	Screen	118"	N	3
3000 Net 5%	Screen	118"	N	2
3000 Net 10%	Screen	118"	N	2
3000 HT 3%	Screen	98"	N	3
3000 HT 5%	Screen	98"	N	2
3000 RR	Screen	98"	N	3
4000 Net 3%	Screen	118"	N	3
4000 Net 5%	Screen	118"	N	2
Ambient Renew 1%	Screen	118"	N	6
Ambient Renew 5%	Screen	118"	N	5
Balmoral*	Blackout	118"	N	9*
Balmoral*	Light Filtering	118"	N	7*
Broad Lines	Translucent	110"	Y	5
M Screen Deco 3%	Screen	98"	Y	8
M Screen Deco 5%	Screen	98"	Y	7
E Screen 1%	Screen	122"	Y	8
E Screen 3%	Screen	122"	Y	7
E Screen 5%	Screen	122"	Y	6
E Screen 10%	Screen	122"	Y	6
E Screen Deco 1%	Screen	122"	Y	9
E Screen Deco 3%	Screen	122"	Y	8
E Screen Koolblack 1%	Screen	122"	Y	11
E Screen Koolblack 3%	Screen	122"	Y	11
E Screen Koolblack 5%	Screen	122"	Y	10
Flocke	Blackout	94"	Y	12
Illusion	Translucent	110"	Y	5
Jersey	Blackout	118"	N	8
Jersey	Light Filtering	118"	N	5
Kleen Screen 1%	Screen	118"	Y	2
Kleen Screen 3%	Screen	118"	Y	1
Kleen Screen 5%	Screen	118"	Y	1
Linen	Translucent	110"	Y	6
Linen Light	Blackout	94"	N	10
Linen Light	Light Filtering	94"	N	6
M Screen 1%	Screen	122"	Y	8
M Screen 3%	Screen	122"	Y	7
M Screen 5%	Screen	122"	Y	6
Mesa	Blackout	118"	N	8
Mesa	Light Filtering	118"	N	5
Pinpointe	Blackout	98"	N	1
S Screen 1%	Screen	122"	N	9
S Screen 4%	Screen	122"	N	9
Sanctuary	Blackout	118"	N	8
Sanctuary	Light Filtering	118"	N	5
Slender Lines	Translucent	110"	Y	5
Slight	Translucent	110"	Y	4
T Screen 1%	Screen	122"	N	9
T Screen 3%	Screen	122"	N	8
T Screen Deco 1%	Screen	122"	N	9
T Screen Deco 3%	Screen	122"	N	8
T Screen Deco 5%	Screen	122"	N	7
T Screen Koolblack 1%	Screen	122"	Y	10
T Screen Koolblack 3%	Screen	122"	Y	10
Tempe	Blackout	118"	N	5
Verona Daylight	Light Filtering	118"	N	6
Verona Twilight	Blackout	118"	N	9
Vizela	Light Filtering	94"	Y	9

*Add 10% surcharge: Balmoral Armour, Chrome & Platinum

Price Charts – Group 1, Group 2 & Group 3

	25"	31"	37"	43"	49"	55"	61"	67"	73"	79"	85"	97"	108"	120"
3" Fascia	72	80	86	92	100	106	114	120	126	134	141	154	166	181
4" Fascia	71	81	89	98	105	116	124	131	141	150	158	176	192	209
4" Fabric Wrapped Fascia – Skyline only	89	101	110	122	131	144	155	164	176	188	197	219	238	261
CD100 or CD110 No Fabric Wrap	75	89	102	118	131	145	159	174	188	202	216	246	n/a	n/a
CD120 or CD110 Fabric Wrap	79	95	110	125	141	156	173	188	204	218	235	267	299	n/a
5" Fascia Dual Shade	134	144	154	163	174	183	193	202	213	223	232	252	n/a	n/a
Cordless	88	88	88	101	101	101	116	116	116	116	116	n/a	n/a	n/a

Group 1		Kleenscreen 3% (118")				Kleenscreen 5% (118")				Pinpointe (98")				(Fabric Width)	
Width to:		25"	31"	37"	43"	49"	55"	61"	67"	73"	79"	85"	97"	108"	120"
Length to:	36"	154	174	191	208	225	240	257	274	291	316	333	366	553	597
	42"	159	180	197	215	233	250	268	286	303	330	348	383	572	617
	48"	163	185	204	223	242	259	278	297	316	343	362	400	591	638
	54"	167	190	210	230	250	269	289	309	329	357	377	417	610	659
	60"	172	195	216	237	258	278	299	320	341	371	392	434	628	679
	66"	176	201	223	245	267	288	310	332	354	384	406	449	647	700
	72"	181	206	229	252	275	297	320	343	366	398	421	466	666	721
	78"	185	211	235	259	284	308	331	355	379	412	436	483	684	741
	84"	189	217	242	267	292	317	341	366	392	425	450	500	702	762
	90"	193	223	248	274	300	327	352	378	404	439	465	517	721	783
	96"	197	228	254	281	309	336	362	390	417	453	479	533	739	803
	108"	206	238	268	296	326	355	383	413	442	480	508	567	777	845
	120"	214	249	280	311	342	374	404	436	467	507	538	600	814	886
	132"	224	259	293	326	359	393	425	459	491	533	567	633	852	927
144"	232	270	306	341	376	412	446	482	517	561	596	667	888	969	

Group 2		3000 Net 5% (118")		3000 Net 10% (118")		3000 HT 5% (98")				Kleenscreen 1%		(Fabric Width)			
Width to:		25"	31"	37"	43"	49"	55"	61"	67"	73"	79"	85"	97"	108"	120"
Length to:	36"	161	182	200	218	236	254	272	290	309	335	354	390	580	626
	42"	166	188	207	227	246	266	285	303	323	352	371	410	602	650
	48"	170	194	214	235	256	276	297	317	338	368	387	428	624	674
	54"	175	201	223	244	266	288	309	331	353	383	405	448	645	698
	60"	181	207	230	253	275	298	321	344	368	399	422	468	667	722
	66"	186	213	237	261	286	310	334	358	382	415	439	487	689	748
	72"	191	219	245	270	295	320	347	372	397	432	457	507	711	772
	78"	195	226	252	278	306	332	358	385	412	447	474	527	732	796
	84"	201	232	259	288	315	343	371	399	426	463	490	546	754	820
	90"	206	238	267	296	326	354	383	412	441	479	508	566	776	844
	96"	211	245	274	305	335	365	396	425	456	495	525	586	798	868
	108"	222	257	290	322	355	387	420	453	485	527	560	625	841	917
	120"	231	269	305	339	375	410	444	480	515	559	593	664	885	965
	132"	242	281	319	357	394	432	469	507	544	590	628	704	928	1013
144"	251	294	334	374	414	454	494	533	573	623	663	742	972	1063	

Group 3		3000 Net 3% (118")		3000 HT 3% (98")		3000 RR (98")		4000 Net 3% (118")		(Fabric Width)					
Width to:		25"	31"	37"	43"	49"	55"	61"	67"	73"	79"	85"	97"	108"	120"
Length to:	36"	163	185	203	222	240	259	277	296	315	342	361	398	589	636
	42"	168	191	211	231	251	271	291	311	331	359	379	419	612	663
	48"	173	197	218	240	261	282	303	324	347	376	397	440	635	688
	54"	179	205	227	249	272	294	317	339	361	393	416	460	658	713
	60"	184	211	234	258	282	306	330	354	377	410	434	481	681	739
	66"	189	217	243	268	293	317	342	368	393	426	452	502	705	764
	72"	194	224	250	277	303	330	356	382	408	443	469	523	728	791
	78"	200	231	258	286	314	341	369	396	424	460	488	543	751	816
	84"	206	237	267	295	323	353	382	411	440	477	506	564	774	841
	90"	211	244	274	305	334	364	395	425	455	494	524	585	797	867
	96"	216	251	282	313	344	376	407	439	470	511	542	605	820	893
	108"	227	264	298	332	365	400	434	467	502	545	579	647	865	944
	120"	237	277	314	350	386	423	460	497	532	579	614	688	911	994
	132"	248	290	330	369	407	446	486	525	564	612	651	729	958	1046
144"	258	303	345	386	428	470	511	553	595	646	687	771	1004	1097	

Any product to the right or below dark line will manufacture with heavy duty clutch and tube. Any product in gray shaded area will require seam (not all fabrics can be seamed, check with customer service). Any orders with a product over 90" width will have an additional oversized fee. See full shipping policy for details.

Price Charts – Group 4, Group 5 & Group 6

	25"	31"	37"	43"	49"	55"	61"	67"	73"	79"	85"	97"	108"	120"
3" Fascia	72	80	86	92	100	106	114	120	126	134	141	154	166	181
4" Fascia	71	81	89	98	105	116	124	131	141	150	158	176	192	209
4" Fabric Wrapped Fascia – Skyline	89	101	110	122	131	144	155	164	176	188	197	219	238	261
CD100 or CD110 No Fabric Wrap	75	89	102	118	131	145	159	174	188	202	216	246	n/a	n/a
CD120 or CD110 Fabric Wrap	79	95	110	125	141	156	173	188	204	218	235	267	299	n/a
5" Fascia Dual Shade	134	144	154	163	174	183	193	202	213	223	232	252	n/a	n/a
Cordless	88	88	88	101	101	101	116	116	116	116	116	n/a	n/a	n/a

Group 4		3000 Net Privacy (118")			3000 Net 1% (118")			Slight (110")			(Fabric Width)				
Width to:		25"	31"	37"	43"	49"	55"	61"	67"	73"	79"	85"	97"	108"	120"
Length to:	36"	166	188	208	227	246	266	285	305	323	352	372	410	603	651
	42"	171	195	216	236	257	278	299	319	340	370	391	433	627	678
	48"	177	203	225	247	269	291	313	335	357	387	410	455	652	706
	54"	183	209	233	256	279	303	327	351	374	406	429	477	676	733
	60"	189	216	242	266	291	316	340	365	391	424	448	499	700	760
	66"	194	224	250	276	302	329	355	381	407	442	468	521	726	788
	72"	200	231	258	286	313	341	369	396	423	460	487	543	750	815
	78"	206	237	267	295	324	354	382	412	440	478	507	565	775	843
	84"	211	245	275	306	336	366	396	426	457	496	526	587	799	870
	90"	217	252	284	315	347	378	411	442	474	515	546	609	824	898
	96"	223	259	292	326	358	391	424	457	490	532	565	631	848	925
	108"	234	273	309	344	380	416	452	488	524	568	604	675	898	980
	120"	246	287	326	364	402	441	480	519	557	604	643	719	947	1034
	132"	257	301	342	384	425	466	507	549	590	641	681	764	996	1089
144"	269	315	359	403	447	491	536	580	624	676	720	809	1046	1143	

Group 5		Ambient Renew 5% (118")			Broad Lines (110")			Illusion (110")			(Fabric Width)				
Width to:		Jersey Light Filtering (118")			Matte (118")			Mesa Light Filtering (118")							
		Sanctuary Light Filtering (118")			Slender Lines (110")			Tempe (118")							
Width to:		25"	31"	37"	43"	49"	55"	61"	67"	73"	79"	85"	97"	108"	120"
Length to:	36"	174	200	223	245	267	289	311	334	356	386	408	454	646	699
	42"	182	209	233	257	281	306	330	354	377	410	434	482	677	735
	48"	189	218	244	270	296	321	348	373	399	434	459	510	709	771
	54"	196	228	255	282	310	338	365	393	421	457	484	540	741	805
	60"	204	236	266	295	324	354	383	413	442	480	509	568	773	841
	66"	212	246	277	308	339	371	401	433	464	503	534	596	804	877
	72"	219	255	288	320	354	386	419	453	485	527	560	626	837	912
	78"	227	264	298	334	368	403	438	473	507	550	585	654	868	947
	84"	234	273	310	347	382	419	456	491	528	573	610	683	901	983
	90"	242	282	320	359	397	435	474	511	550	596	635	711	932	1019
	96"	249	292	332	372	412	452	491	531	571	620	659	740	964	1054
	108"	264	310	353	397	440	484	527	571	614	667	710	797	1028	1125
	120"	278	328	375	422	469	517	564	610	657	713	760	855	1092	1196
	132"	293	347	397	447	498	549	600	650	700	760	811	911	1155	1266
144"	308	364	419	474	527	582	635	690	743	806	861	969	1219	1338	

Group 6		Ambient Renew 1% (118")			E Screen 5% (122")			E Screen 10% (122")			Linen (110")				(Fabric Width)	
Width to:		Linen Light – Light Filtering (94")			M Screen 5% (122")			Verona Daylight (118")								
Width to:		25"	31"	37"	43"	49"	55"	61"	67"	73"	79"	85"	97"	108"	120"	
Length to:	36"	179	205	229	252	276	300	323	348	371	403	426	474	665	721	
	42"	187	215	240	267	292	318	343	369	395	428	455	505	700	761	
	48"	195	226	253	280	309	336	363	391	419	455	482	538	735	800	
	54"	204	235	266	295	324	354	383	413	442	481	510	569	771	840	
	60"	211	246	277	309	340	372	403	435	466	506	538	601	806	879	
	66"	219	256	290	323	356	390	423	457	490	532	566	632	842	918	
	72"	228	266	301	337	373	407	443	479	515	558	593	665	877	958	
	78"	236	276	314	351	389	426	463	501	539	584	622	696	912	996	
	84"	245	287	326	365	404	444	483	523	562	610	649	728	948	1036	
	90"	252	296	338	379	421	462	503	545	586	635	677	760	983	1075	
	96"	260	307	350	394	437	480	523	567	610	662	705	792	1019	1115	
	108"	277	327	374	421	468	516	563	610	657	713	760	855	1089	1193	
	120"	293	348	399	449	501	552	603	654	706	765	816	919	1160	1272	
	132"	310	368	423	478	533	588	644	698	754	817	872	982	1231	1350	
144"	327	389	447	506	565	624	684	742	801	868	927	1046	1302	1429		

Any product to the right or below dark line will manufacture with heavy duty clutch and tube. Any product in gray shaded area will require seam (not all fabrics can be seamed, check with customer service). Any orders with a product over 90" width will have an additional oversized fee. See full shipping policy for details.

Price Charts – Group 7, Group 8 & Group 9

	25"	31"	37"	43"	49"	55"	61"	67"	73"	79"	85"	97"	108"	120"
3" Fascia	72	80	86	92	100	106	114	120	126	134	141	154	166	181
4" Fascia	71	81	89	98	105	116	124	131	141	150	158	176	192	209
4" Fabric Wrapped Fascia – Skyline	89	101	110	122	131	144	155	164	176	188	197	219	238	261
CD100 or CD110 No Fabric Wrap	75	89	102	118	131	145	159	174	188	202	216	246	n/a	n/a
CD120 or CD110 Fabric Wrap	79	95	110	125	141	156	173	188	204	218	235	267	299	n/a
5" Fascia Dual Shade	134	144	154	163	174	183	193	202	213	223	232	252	n/a	n/a
Cordless	88	88	88	101	101	101	116	116	116	116	116	n/a	n/a	n/a

Group 7		Balmoral Light Filtering* (118") M Screen 3% (122")			M Screen Deco 5% (98") T Screen Deco 5% (122")			E Screen 3% (122") <small>*10% surcharge on Balmoral Patterns Armor, Chrome & Platinum</small>				(Fabric Width)			
Width to:		25"	31"	37"	43"	49"	55"	61"	67"	73"	79"	85"	97"	108"	120"
Length to:	36"	185	212	237	263	288	313	338	363	389	422	447	497	691	750
	42"	193	224	251	278	306	333	360	387	415	450	478	532	729	793
	48"	203	235	265	294	323	353	382	412	441	479	508	567	768	836
	54"	211	246	277	309	340	372	403	436	467	507	539	602	806	879
	60"	221	257	291	324	358	392	425	459	494	536	569	636	845	922
	66"	229	268	303	340	376	412	447	483	519	564	600	671	884	965
	72"	238	279	317	355	393	432	469	507	545	591	630	706	923	1008
	78"	247	290	331	371	411	450	491	531	571	620	660	740	962	1051
	84"	256	301	343	386	428	470	513	555	597	648	691	775	1001	1094
	90"	266	313	357	401	446	490	534	580	624	676	721	810	1038	1137
	96"	274	323	371	417	463	510	557	604	650	705	752	845	1077	1180
	108"	292	345	397	447	499	549	601	651	702	761	813	915	1155	1266
	120"	310	369	423	479	533	589	645	699	755	818	874	984	1233	1352
	132"	328	391	449	509	569	628	688	748	807	875	935	1053	1309	1439
144"	345	413	477	540	604	668	732	796	859	931	995	1122	1387	1525	

Group 8		M Screen Deco 3% (98") Jersey Blackout (118") Sanctuary Blackout (118")			E Screen 1% (122") Mesa Blackout (118") T Screen 3% (122")			E Screen Deco 3% (122") M Screen 1% (122") T Screen Deco 3% (122")				(Fabric Width)			
Width to:		25"	31"	37"	43"	49"	55"	61"	67"	73"	79"	85"	97"	108"	120"
Length to:	36"	189	218	245	272	298	324	351	378	404	439	465	518	712	775
	42"	200	231	259	289	317	345	375	403	433	469	498	555	754	821
	48"	209	243	274	306	336	368	398	429	461	500	531	593	796	868
	54"	218	255	289	321	355	389	422	456	489	531	564	631	838	915
	60"	228	267	302	338	374	411	446	482	518	562	597	669	880	961
	66"	238	279	317	355	394	432	469	508	546	592	630	707	922	1008
	72"	248	291	332	372	413	453	494	533	574	623	664	744	964	1054
	78"	257	303	345	389	432	475	517	560	603	654	696	782	1006	1101
	84"	267	315	360	405	450	496	541	586	631	685	730	820	1048	1148
	90"	277	328	375	422	469	517	565	612	659	715	762	858	1090	1195
	96"	287	339	389	439	488	539	588	638	688	746	796	896	1132	1241
	108"	306	363	418	473	527	582	635	690	744	807	862	971	1216	1335
	120"	326	387	446	506	565	624	684	742	801	868	928	1046	1300	1428
	132"	344	412	476	539	603	667	731	795	858	930	994	1121	1384	1521
144"	364	436	504	572	642	710	778	846	915	991	1061	1197	1468	1615	

Group 9		Balmoral Blackout* (118") T Screen 1% (122")			E Screen Deco 1% (122") T Screen Deco 1% (122")			Screen 1 & 4% (118") Verona Twilight (118")				(Fabric Width)			
Width to:		25"	31"	37"	43"	49"	55"	61"	67"	73"	79"	85"	97"	108"	120"
Length to:	36"	197	229	257	286	315	343	372	401	429	466	495	552	749	815
	42"	208	243	274	305	336	368	399	429	461	501	531	594	796	867
	48"	219	256	290	323	357	392	425	459	492	534	569	636	842	920
	54"	230	270	306	342	379	415	452	488	525	569	606	678	889	971
	60"	240	282	322	361	400	439	479	518	557	604	643	721	937	1024
	66"	252	296	338	380	421	463	505	547	588	638	679	763	984	1076
	72"	263	310	354	399	443	487	531	575	621	673	717	805	1031	1129
	78"	274	323	371	417	464	511	559	605	652	707	754	847	1077	1181
	84"	285	337	386	436	485	536	585	634	684	741	791	890	1125	1234
	90"	295	351	402	455	507	559	611	664	716	776	828	932	1172	1285
	96"	307	364	419	474	528	583	637	693	748	811	865	974	1219	1338
	108"	328	391	450	511	571	631	691	751	811	879	939	1059	1314	1443
	120"	350	418	483	548	613	679	744	810	875	948	1013	1143	1407	1547
	132"	372	445	516	586	656	727	797	868	939	1016	1088	1229	1502	1652
144"	394	471	548	624	699	775	851	926	1002	1086	1161	1313	1596	1757	

Any product to the right or below dark line will manufacture with heavy duty clutch and tube. Any product in gray shaded area will require seam (not all fabrics can be seamed, check with customer service). Any orders with a product over 90" width will have an additional oversized fee. See full shipping policy for details.

Price Charts – Group 10, Group 11 & Group 12

	25"	31"	37"	43"	49"	55"	61"	67"	73"	79"	85"	97"	108"	120"
3" Fascia	72	80	86	92	100	106	114	120	126	134	141	154	166	181
4" Fascia	71	81	89	98	105	116	124	131	141	150	158	176	192	209
4" Fabric Wrapped Fascia – Skyline	89	101	110	122	131	144	155	164	176	188	197	219	238	261
CD100 or CD110 No Fabric Wrap	75	89	102	118	131	145	159	174	188	202	216	246	n/a	n/a
CD120 or CD110 Fabric Wrap	79	95	110	125	141	156	173	188	204	218	235	267	299	n/a
5" Fascia Dual Shade	134	144	154	163	174	183	193	202	213	223	232	252	n/a	n/a
Cordless	88	88	88	101	101	101	116	116	116	116	116	n/a	n/a	n/a

Group 10		E Screen Koolblack 5% (122") T Screen Koolblack 1% & 3% (122")											Linen Light – Blackout (94") Vizela (94")		(Fabric Width)	
Width to:		25"	31"	37"	43"	49"	55"	61"	67"	73"	79"	85"	97"	108"	120"	
Length to:	36"	223	260	296	331	366	401	437	471	507	550	586	656	860	940	
	42"	237	278	317	356	395	434	471	510	549	596	634	712	923	1009	
	48"	252	296	338	381	423	465	507	549	591	642	684	768	985	1078	
	54"	266	314	360	405	452	497	543	588	633	687	733	824	1048	1148	
	60"	280	332	381	431	480	528	578	627	676	733	782	880	1110	1217	
	66"	295	350	402	456	508	561	613	666	718	778	831	936	1172	1286	
	72"	310	368	424	480	536	592	648	705	760	824	880	992	1235	1356	
	78"	323	385	445	505	564	624	684	742	802	869	929	1048	1297	1425	
	84"	338	404	466	529	592	655	718	781	844	916	978	1104	1360	1494	
	90"	353	422	488	554	621	688	754	820	886	961	1027	1160	1422	1563	
	96"	366	440	509	580	649	719	789	859	928	1006	1076	1216	1484	1633	
	108"	396	476	552	629	706	782	859	937	1013	1097	1174	1328	1609	1771	
	120"	424	511	595	678	762	846	929	1013	1097	1189	1273	1440	1734	1910	
	132"	454	547	637	729	819	909	1001	1091	1181	1280	1370	1552	1859	2049	
144"	482	583	680	778	876	973	1071	1169	1266	1371	1469	1664	1982	2187		

Group 11		E Screen Koolblack 1% & 3% (122")											(Fabric Width)		
Width to:		25"	31"	37"	43"	49"	55"	61"	67"	73"	79"	85"	97"	108"	120"
Length to:	36"	246	289	330	371	412	453	494	534	575	624	665	747	961	1051
	42"	264	311	356	401	446	491	537	581	626	679	725	814	1035	1135
	48"	280	333	381	431	480	529	579	628	677	734	783	882	1111	1218
	54"	298	354	407	461	515	568	621	674	728	789	842	949	1187	1302
	60"	315	376	434	490	548	606	664	721	779	844	902	1016	1261	1385
	66"	333	397	459	521	583	644	706	768	830	899	961	1085	1337	1469
	72"	350	419	485	550	616	683	749	814	880	954	1020	1152	1411	1552
	78"	368	440	510	581	651	720	791	861	931	1009	1079	1219	1487	1636
	84"	385	462	537	610	685	759	834	907	982	1064	1138	1286	1562	1720
	90"	402	483	562	641	719	797	876	954	1032	1119	1197	1355	1637	1803
	96"	420	505	588	670	753	836	918	1001	1084	1174	1257	1422	1713	1887
	108"	455	548	639	730	821	912	1003	1094	1185	1284	1374	1557	1863	2054
	120"	489	591	691	790	889	989	1088	1188	1286	1393	1493	1692	2013	2221
	132"	524	634	742	849	958	1065	1173	1281	1388	1504	1612	1827	2163	2388
144"	559	677	794	909	1026	1141	1258	1373	1490	1614	1729	1961	2313	2555	

Group 12		Flocke (94")											(Fabric Width)		
Width to:		25"	31"	37"	43"	49"	55"	61"	67"	73"	79"	85"	97"	108"	120"
Length to:	36"	290	343	395	447	499	550	602	653	705	764	816	919	1151	1263
	42"	313	373	429	486	544	601	657	715	772	837	894	1008	1251	1373
	48"	335	401	463	526	589	651	714	777	839	909	972	1097	1349	1484
	54"	358	429	498	566	634	702	770	838	906	983	1050	1187	1449	1594
	60"	381	458	531	605	679	753	826	900	973	1055	1129	1276	1549	1705
	66"	404	486	566	645	725	803	882	962	1041	1128	1206	1365	1649	1815
	72"	427	515	600	685	770	854	939	1024	1108	1200	1285	1454	1747	1926
	78"	450	544	634	725	814	904	994	1085	1175	1274	1364	1545	1847	2036
	84"	474	572	668	763	859	956	1051	1147	1242	1346	1442	1634	1947	2147
	90"	497	601	702	803	904	1006	1107	1209	1309	1419	1520	1723	2045	2258
	96"	520	629	736	843	949	1056	1163	1271	1377	1492	1598	1812	2145	2368
	108"	566	687	804	922	1040	1158	1276	1393	1511	1637	1755	1991	2345	2589
	120"	612	743	873	1002	1130	1259	1388	1517	1646	1783	1911	2169	2543	2810
	132"	657	800	941	1080	1220	1361	1500	1640	1781	1928	2069	2348	2742	3031
144"	704	858	1009	1159	1310	1462	1613	1764	1915	2074	2225	2526	2941	3252	

Any product to the right or below dark line will manufacture with heavy duty clutch & tube. Any product in gray shaded area will require seam (not all fabrics can be seamed, check with customer service). Any orders with a product over 90" width will have an additional oversized fee. See full shipping policy for details.

Automate Motorization

AUTOMATE | ARC™ (Automate Radio Communication) motors offer a wire free or wired motorization option that is an easy to use and program solution to suit a large range of applications, with varying torques and speed levels.



Features include:

- Automate motorization available in 1 A/C Wired style or 3 Li-ion Battery styles to suit your project.
- Leveling control
- Simple limit setting and adjustment
- 3 operational speed settings available
- Favorite position
- 2-way RF communication
- 5-year motor warranty

Lithium-Ion Battery Wire Free Motorization

AUTOMATE | Li-ion ARC motors offer a wire free, rechargeable, easy to use and program solution. Automate motors feature a charge-management circuit that adjusts the amount of electrical current feeding the battery. As a battery reaches its maximum charge, the circuit will limit the current eventually shutting off power once the battery is fully charged.

- Rechargeable built-in Li-ion battery with up to 500 up and down cycles per charge. These numbers are impacted by shade size and fabric weight, but on average our motors in prevalent size shades are able to last about a year and half under normal operation (one cycle per day).
- Optional solar powered charger
- Minimum Widths:
 - LI-ION 1.1nm 21.5"
 - LI-ION 2.0nm 30"
 - LI-ION 3.0nm 34"
- Maximum sizes. Please note sizes listed are based on average and can vary based on fabric:
 - LI-ION 1.1nm 84" x 84"
 - LI-ION 2.0nm 120" x 120"
 - LI-ION 3.0nm 144" x 144"

Automate ARC Li-ion Motors:

• LI-ION 1.1nm DCQRF	\$342	Retail
• LI-ION 2.0nm DCQRF	\$445	Retail
• LI-ION 3.0nm DCQRF	\$704	Retail
• 5v Standard Wall Charger	\$71	Retail
• 5v Magnetic Charger (expect longer charge time of 9-12 hours)	\$71	Retail
• 8" Charger Cable Extender	\$14	Retail
• 48" Charger Cable Extender	\$30	Retail
• Battery Tube Only (DCRF Motors Only) requires 8 AA batteries – lithium recommended	\$94	Retail
• 8 Lithium Batteries for Battery Tube	\$90	Retail
• Solar Panel	\$400	Retail

AC Motorization

Automate | AC tubular motors combine the simple, intuitive features of ARC "Automate Radio Communication" with the higher lifting capacity of an AC motor for larger shade applications.

- Minimum width: 34"
- Maximum size based on average and can vary based on fabric: 144" x 144"

Automate ARC AC Motors:

• ACRF	\$731	Retail
--------	-------	--------

Wireless Controls

Automate | Compatible with all ARC motors, Paradigm remotes and switches feature a contemporary design with touch sensitive controls.

- Controls include 3 remote styles and 3 cut in wall switches
- Optional Automate Pulse Hub with Wi-Fi built in can be used control shades with most smart devices and some home automation systems. A local wireless network will be required.

Automate Remote Control:

• Push 5 Remote – Available in White or Black	\$169	Retail
• Push 15 Remote – Available in White or Black	\$194	Retail
• Paradigm 1 Channel Remote	\$159	Retail
• Paradigm 1 Channel Cut in Wall Switch	\$124	Retail
• Paradigm 2 Channel Cut in Wall Switch	\$142	Retail
• Paradigm 15 Channel Cut in Wall Switch	\$158	Retail
• Automate Pulse Hub 2	\$519	Retail
• Automate Interior Sun Sensor	\$81	Retail

Basics Motorization

BASICS AUTOMATE | ARC™ (Automate Radio Communication) motors offer an entry level, wire free rechargeable option for simple motorization needs.



Features and Notes:

- Only available in a 1.1 NM motor
- Can only be operated using the 5 Channel BASICS Remote
- Does not integrate with the Pulse 2 Hub
- Simple limit setting and adjustment
- 2-way RF communication
- 3-year motor warranty

BASICS Lithium-Ion Battery Wire Free Motorization

BASICS AUTOMATE | Li-ion ARC motors offer a wire free, rechargeable, easy to use and program solution. Automate motors feature a charge-management circuit that adjusts the amount of electrical current feeding the battery. As a battery reaches its maximum charge, the circuit will limit the current eventually shutting off power once the battery is fully charged.

- Rechargeable built-in Li-ion battery with up to 500 up and down cycles per charge. These numbers are impacted by shade size and fabric weight, but on average our motors in prevalent size shades are able to last about a year and half under normal operation (one cycle per day).
- Minimum Widths: Basics LI-ION 1.1nm 21"
- Maximum sizes. 84" x 84" Please note sizes listed are based on average and can vary based on fabric:

BASICS Automate Li-ion Options:

• BASICS Automate LI-ION 1.1nm	\$167	Retail
• Wall Charger	\$71	Retail
• 5 Channel Remote	\$40	Retail
• Solar Panel	\$400	Retail

Warranty

CACO, Inc. will extend a limited lifetime warranty on Serenity Roller Shade clutches not to exceed 25 years, 3 years on chain for roller shade operation, a limited lifetime warranty on interior use Textstyle fabrics not to exceed 25 years, a limited 10 year warranty on interior use Mermet Fabrics, a limited 5 year warranty on interior use vinyl fabrics and BASICS Automate motors provide a limited 3 year warranty, Rollease Acmeda Automate motors provide a limited 5 year warranty on battery motors and a limited 7 year warranty on direct wired motors. Each shade is warranted to be free from defects in materials and workmanship to the original owner, provided that the shades were properly installed in a window, door or other interior area for which they intended, maintained and cleaned with the manufacturer recommendations.

Damage resulting from misuse, abuse, exposure to the elements, including but not limited to exposure to salty air, discoloration due to sunlight or passage of time, exposure to humidity, accidents, the use of steam, bleach, or any caustic abrasive, or solvent based cleaners, improper installation, alterations or normal wear and tear upon the shades are not covered by this warranty. Some fading or reduction in color intensity may occur and should not be deemed defective. Returns for the above-mentioned reasons are not warranted.

The obligation of CACO's manufactured products and its distributors is limited to repair or replacement of the shades or components found to be defective, at our option, provided the shades are returned to an authorized CACO dealer or distributor and accompanied by "proof of purchase CACO is not responsible for any shipping or labor costs associated for measuring, removing and re-installing blind from installed windows or fabricating alterations.

This warranty is exclusive and in lieu of all other obligations, liabilities, or warranties. In no event shall CACO be liable or responsible for incidental or consequential damages, or for any other direct or indirect damage, loss, cost, expense, or fee. Some states do not allow the exclusion or limitations of incidental or consequential damages, so this limitation may not apply to you. This warranty gives you specific rights, and you may also have other rights, which vary from state to state.

Wood Horizontal Blinds

Delta Woods – Pricing

2" Delta Woods Painted

3600-White		3413-Snow White			3421-Almost White			3401-Alabaster						
Width to:		21	24	29	32	36	42	48	54	60	66	72	78	84
Length to:	30	162	183	210	225	240	261	274	295	391	403	413	462	512
	36	147	168	193	210	226	247	269	296	360	379	387	439	489
	42	161	186	217	230	250	277	297	332	401	413	439	492	550
	48	171	194	236	255	273	301	331	363	442	467	490	552	615
	54	191	219	259	278	296	332	360	405	480	517	550	615	681
	61	211	238	279	302	321	358	392	442	517	566	597	667	739
	66	227	261	302	323	345	383	433	482	570	615	656	732	807
	73	252	286	321	345	374	416	469	523	617	656	726	777	858
	78	278	319	353	381	405	461	518	568	648	726	824	894	980
	84	328	373	418	446	478	551	620	685	791	890	942	1083	1192

2 1/2" Delta Woods Painted

W600-White		W413-Snow White			W421-Almost White			W401-Alabaster						
Width to:		21	24	29	32	36	42	48	54	60	66	72	78	84
Length to:	30	182	206	237	254	271	293	309	333	437	452	464	518	577
	36	206	228	258	278	295	321	343	377	484	505	516	576	635
	42	222	247	286	301	322	355	379	417	535	547	576	639	704
	48	231	261	307	331	351	381	416	455	580	610	636	707	779
	54	255	288	333	356	377	417	448	500	623	667	704	779	856
	61	279	309	357	381	406	447	486	544	667	723	759	840	923
	66	297	334	383	408	433	478	534	588	728	779	825	913	1000
	73	325	364	406	433	465	516	575	637	782	825	907	966	1059
	78	356	401	442	476	500	566	632	689	814	907	1018	1097	1198
	84	392	441	481	513	544	622	694	761	910	1018	1071	1226	1346

2" Delta Woods Stained

3406-Natural		3407-Maple			3410-Golden Oak			3901-Chocolate		7419-Black				
3402-Rosewood		3412-Mahogany			3604-Walnut									
Width to:		21	24	29	32	36	42	48	54	60	66	72	78	84
Length to:	30	167	189	222	237	254	272	291	309	410	420	433	485	535
	36	190	213	241	261	273	300	321	350	454	470	483	534	588
	42	205	228	263	282	301	330	354	385	498	512	535	595	653
	48	222	246	286	306	329	356	384	425	539	567	590	656	725
	54	240	266	311	331	351	385	418	464	579	623	653	724	797
	61	261	291	332	356	379	417	452	503	622	669	705	781	856
	66	278	313	357	380	406	444	495	547	674	728	767	847	927
	73	300	337	379	406	427	480	535	590	728	767	811	897	983
	78	330	372	412	437	465	525	587	637	757	841	924	1016	1110
	84	362	412	448	477	503	577	647	702	849	942	1031	1139	1247

Standard Features

- Valance, slat and bottom rail from hand selected kiln dried hardwood
- Deco crown valance
- Trapezoid bottom rail
- Color coordinated components, ladders
- Durable 2" x 2" steel headrail
- Limited Lifetime Warranty
- Standard valance returns for outside mount installation 2 3/4"
- Wand tilt-only

Optional items

- Valance returns for inside mount installation no charge when requested
- Motorized tilt feature see page 12
- Extra valance material \$12.60 per foot retail
- Cut outs per side or center \$15.75 surcharge
- Fire retardant finish is available by quotation

Special Notes

- Blind ladder will be color coordinated, but inner lift cord will be white.
- Valance measurements are from inside miter to inside miter
- Standard valance returns for outside mount installation 2 3/4"
- Smallest return size is 1/2"
- Allowances:
Blind width (i.m./i.b.) 1/2"
Blind width (o.m./o.b.) exact
Blind length (i.m./i.b.) +/- 1/8"
- Single Blinds only, no multiple blinds on one headrail
- Minimum width 17" O.M.
- Maximum single blind 84" x 84"
- Minimum length 24"
- Maximum length 84"

Stacking Chart (these are approximate measurements)	
2" Delta Woods	
	Braided Ladder
12"	4"
24"	5"
36"	5 7/8"
48"	6 3/4"
60"	7 5/8"
72"	8 1/2"
84"	9 5/8"
96"	10 1/4"
108"	11 3/8"
120"	12 1/4"

Delta Wood Ladder/Tape Schedule	
2 Ladder	8 1/2"-36"
3 Ladder	36 1/8"-58"
4 Ladder	58 1/8"-84"
5 Ladder	84 1/8"-108"

Delta Woods – Motorization

Tilt Motorization

AUTOMATE | ARC™ (Automate Radio Communication) motors offer a wire free or wired motorization option that is an easy to use and program solution to suit a large range of applications, with varying torques and speed levels.



Features include:

- Automate tilt motorization available
- Leveling control
- Simple limit setting and adjustment
- 3 operational speed settings available
- Favorite position
- 2-way RF communication
- 5-year motor warranty

Automate ARC Li-ion Motors:

- VT 1.0 Tilt DC motor (including battery wand and batteries) Retail \$438
- VT 1.0 Tilt DC motor only \$273

Optional Power Supply:

- Plug in Power Supply \$75
- Li-ion Rechargeable Battery Pack \$218
- 12 V Wall Charger \$71

Lithium Ion Battery Wire Free Motorization

AUTOMATE™ | ARC™ Venetian blind motor enables motorized tilting function of most 2" venetian blinds. Precisely control the openness of blind vanes or simply recall a favorite position.

- Rechargeable battery pack with Li-ion battery
- Minimum Widths 18"
- Maximum sizes.
2" Delta Wood Blinds 54 sq. ft.

Automate Remote Control:

- Push 5 Remote – Available in White or Black Retail \$169
- Push 15 Remote – Available in White or Black \$194
- Paradigm 1 Channel Remote \$159
- Paradigm 1 Channel Cut in Wall Switch \$124
- Paradigm 2 Channel Cut in Wall Switch \$142
- Paradigm 15 Channel Cut in Wall Switch \$158
- Automate Pulse Hub 2 \$519
- Automate Interior Sun Sensor \$81

Wireless Controls

Automate | Compatible with all ARC motors, Paradigm remotes and switches feature a contemporary design with touch sensitive controls.

- Controls include 3 remote styles and 3 cut in wall switches
- Optional Automate Pulse Hub with Wi-Fi built in can be used control blinds with most smart devices and some home automation systems. A local wireless network will be required.

Wood Horizontal Blinds

Delta Woods – Warranty

CACO, Inc. will extend a limited lifetime warranty on **Delta Woods**, a limited lifetime warranty on the head rail and components for **Delta Woods**; a limited 3-year warranty on **Delta Woods** operating cords, valance, slats and bottom rail; **Rollease Acmeda 2" Tilt Motor** has a limited 7 year warranty.

Each blind is warranted to be free from defects in materials and workmanship to the original owner and limited to manually operated products only, provided that the blinds were: 1.) Installed in a residential dwelling. 2.) Properly installed in accordance with the installation instructions which accompany each blind to be installed in a window, door or other interior area for which they were intended. 3.) Maintained and cleaned in compliance with the manufacturer's recommendations.

Damage resulting from misuse, abuse, exposure to the elements, including but not limited to exposure to salty air, discoloration due to sunlight or passage of time, exposure to humidity, accidents, the use of steam, bleach, or any caustic abrasive, or solvent based cleaners, alterations, improper installation or normal wear and tear upon the blinds are not covered by this warranty. Cord wear shall be considered as normal wear and tear. Some minor warping, natural variations in the grain, color, fading or discoloration may occur within time (these are considered part of the aging process for wood painted, stained and clear finishes) and should not be deemed defective. Returns for the above-mentioned reasons are not warranted.

The obligation of CACO's manufactured products and its distributors is limited to repair or replacement of the blinds or components found to be defective, at our option, provided the blinds are returned to an authorized CACO dealer or distributor and accompanied by "proof of purchase". CACO is not responsible for any shipping or labor costs associated for measuring, removing and re-installing blind from installed windows or fabricating alterations.

This warranty is exclusive and in lieu of all other obligations, liabilities, or warranties. In no event shall **CACO** be liable or responsible for incidental or consequential damages, or for any other direct or indirect damage, loss, cost, expense or fee. This warranty gives you specific rights, and you may also have other rights, which vary from state to state.

Avalon Faux Wood

2" Faux Wood - Whites

		FW-01 Bright White EFW-01 Embossed Bright White					FW-02 Snow White EFW-02 Embossed Snow White					FW-03 Antique White EFW-03 Embossed Antique White					FW-04 Alabaster EFW-04 Embossed Alabaster				
Width to:		21	24	29	32	36	42	48	54	60	66	72	78	84							
Length to:	30	129	139	145	158	167	183	191	204	253	275	306	317	330							
	36	139	145	158	171	182	198	211	224	273	296	328	350	370							
	42	144	158	171	182	188	211	226	240	286	312	348	373	399							
	48	158	168	182	188	201	224	240	257	305	336	370	398	422							
	54	166	179	188	201	215	239	257	269	328	354	390	421	450							
	61	171	185	198	212	228	246	269	286	338	374	414	445	474							
	66	182	191	211	226	240	264	283	301	358	410	435	469	501							
	73	190	203	218	237	250	276	295	318	377	414	459	496	530							
	78	198	212	230	245	261	292	315	334	398	434	480	515	551							
	84	203	217	236	251	270	299	322	345	404	444	492	531	569							

2 1/2" Faux Wood

		FW-01 Bright White					FW-02 Snow White					FW-03 Antique White					FW-04 Alabaster				
Width to:		21	24	29	32	36	42	48	54	60	66	72	78	84							
Length to:	30	134	141	149	162	170	186	197	211	260	279	311	325	337							
	36	141	149	162	179	185	203	215	230	278	303	336	356	380							
	42	148	162	179	185	195	215	231	245	293	322	354	382	406							
	48	162	171	185	195	206	230	245	262	310	346	380	405	432							
	54	169	183	195	206	220	243	262	274	336	364	401	429	459							
	61	179	188	203	216	233	254	274	292	348	383	425	456	487							
	66	185	197	215	232	245	272	290	311	368	422	447	479	513							
	73	196	207	225	242	257	286	302	328	384	425	472	509	546							
	78	203	216	236	251	269	300	322	344	405	445	494	530	562							
	84	207	224	241	259	275	308	332	352	414	454	504	547	583							

2" Faux Wood - Colors

		FW-26 Slate					FW-28 Smoke					EFW-06 Embossed Birch					EFW-07 Embossed Maple					EFW-08 Embossed Cherry					EFW-09 Embossed Mahogany				
Width to:		21	24	29	32	36	42	48	54	60	66	72	78	84																	
Length to:	30	143	149	163	173	185	203	213	228	278	304	336	350	368																	
	36	149	163	173	191	199	223	233	250	303	326	366	386	413																	
	42	162	173	191	199	209	233	252	269	317	348	384	415	443																	
	48	173	187	199	209	225	250	269	287	335	373	413	440	470																	
	54	183	196	209	225	239	268	287	299	366	393	436	469	500																	
	61	191	206	223	236	254	275	299	318	377	419	463	496	530																	
	66	199	213	233	252	269	296	315	338	398	457	484	525	558																	
	73	212	226	243	267	281	312	333	357	420	463	512	554	591																	
	78	223	236	255	274	292	330	352	377	440	483	537	576	625																	
	84	226	242	260	282	300	335	362	387	448	495	550	592	638																	

2" Faux Wood Premium Printed

		PFW-351 Natural					PFW-353 Pecan					PFW-354 Oak					PFW-356 Chestnut					PFW-357 Mahogany				
Width to:		21	24	29	32	36	42	48	54	60	66	72	78	84												
Length to:	30	149	161	171	185	195	212	225	242	291	319	354	370	386												
	36	161	171	185	203	211	234	246	265	318	344	385	410	434												
	42	170	185	203	211	223	246	267	284	333	367	405	437	469												
	48	185	196	211	223	238	265	284	304	351	394	434	467	497												
	54	194	207	223	238	253	283	304	315	385	417	462	496	531												
	61	203	219	234	248	270	292	315	338	398	442	489	526	560												
	66	211	225	246	267	284	313	336	360	421	484	514	554	592												
	73	224	241	258	282	297	331	351	381	443	489	545	588	630												
	78	234	248	271	291	310	349	375	398	467	512	572	612	653												
	84	241	255	280	299	318	356	385	411	476	525	582	631	678												

Avalon Faux Wood Features

Standard Features

- Valance, slat and bottom rail are manufactured from space age PVC foam along UV inhibitors to provide longer color fastness with a UV rating of 500+ hours
- Flame retardant (meets NFPA small scale flame test)
- Moisture, heat and fade resistant
- Slats are solid color all the way through
- 2" Designer whites in both smooth and embossed finishes along with optional wood stain finishes;
- 2 1/2" available in smooth white finishes only
- Rectangle Bottom rail
- Color coordinated components, ladders and wands
- Durable 2" x 2" steel headrail
- Wand tilt only up to 60°
- Limited Lifetime Warranty

Avalon Faux Wood Stacking Chart

(these are approximate measurements)

	Cloth Tapes	Braided Ladder
12"	4"	4"
24"	5"	5"
36"	6"	5 7/8"
48"	7"	6 3/4"
60"	8 1/2"	7 5/8"
72"	10"	8 1/2"
84"	11 1/2"	9 5/8"
96"	13"	10 1/4"
108"	14 1/2"	11 3/8"
120"	16"	12 1/4"

Optional items

- Valance returns for inside mount installation n/c when requested
- Motorized tilt feature
- Cut outs per side or center \$17
- Extra valance material \$ 6.70 per foot retail

Special Notes

- Blind ladder will be color coordinated, but inner lift cord will be white.
- Standard valance returns for outside mount installation 2 3/4"
- Valance measurements are from inside miter to inside miter
- Smallest return size is 1/2"
- Single Blinds only, no multiple blinds on one headrail
- Minimum width 17" O.M.
- Maximum single blind 84" x 84"
- Minimum length 24"
- Maximum length 84"
- Allowances Blind width inside mount 1/2", length +/- 1/8"

Avalon Faux Wood Ladder/Tape Schedule

2 Ladder	9"-23"
3 Ladder	23 1/8"-36"
4 Ladder	36"-49"
5 Ladder	49 1/8"-62"
6 Ladder	62 1/8"-75"
7 Ladder	75 1/8"-88"
8 Ladder	88 1/8"-101"

Tilt Motorization

AUTOMATE | ARC™ (Automate Radio Communication) motors offer a wire free or wired motorization option that is an easy to use and program solution to suit a large range of applications, with varying torques and speed levels.



Features include:

- Automate tilt motorization available
- Leveling control
- Simple limit setting and adjustment
- 3 operational speed settings available
- Favorite position
- 2-way RF communication
- 5-year motor warranty

Automate ARC Li-ion Motors:

- VT 1.0 Tilt DC motor (including battery wand and batteries) Retail \$438
- VT 1.0 Tilt DC motor only \$273

Optional Power Supply:

- Plug in Power Supply \$75
- Li-ion Rechargeable Battery Pack \$218
- 12 V Wall Charger \$71

Lithium Ion Battery Wire Free Motorization

AUTOMATE™ | ARC™ Venetian blind motor enables motorized tilting function of most 2" venetian blinds. Precisely control the openness of blind vanes or simply recall a favorite position.

- Rechargeable battery pack with Li-ion battery
- Minimum Widths 18"
- Maximum sizes.

2" Avalon Faux Wood Blinds 36 sq. ft.

Automate Remote Control:

- Push 5 Remote – Available in White or Black Retail \$169
- Push 15 Remote – Available in White or Black \$194
- Paradigm 1 Channel Remote \$159
- Paradigm 1 Channel Cut in Wall Switch \$124
- Paradigm 2 Channel Cut in Wall Switch \$142
- Paradigm 15 Channel Cut in Wall Switch \$158
- Automate Pulse Hub 2 \$519
- Automate Interior Sun Sensor \$81

Wireless Controls

Automate | Compatible with all ARC motors, Paradigm remotes and switches feature a contemporary design with touch sensitive controls.

- Controls include 3 remote styles and 3 cut in wall switches
- Optional Automate Pulse Hub with Wi-Fi built in can be used control blinds with most smart devices and some home automation systems. A local wireless network will be required.

Avalon Faux Wood Warranty

CACO, Inc. will extend a limited lifetime warranty on **Avalon Faux Wood**, a limited lifetime warranty on the head rail and components for **Avalon Faux Wood**; a limited 3-year warranty on **Avalon Faux Wood** operating cords, valance, slats and bottom rail; **Rollease Acmeda 2" Tilt Motor** has a limited 7 year warranty.

Each blind is warranted to be free from defects in materials and workmanship to the original owner and limited to manually operated products only, provided that the blinds were: 1.) Installed in a residential dwelling. 2.) Properly installed in accordance with the installation instructions which accompany each blind to be installed in a window, door or other interior area for which they were intended. 3.) Maintained and cleaned in compliance with the manufacturer's recommendations.

Damage resulting from misuse, abuse, exposure to the elements, including but not limited to exposure to salty air, discoloration due to sunlight or passage of time, exposure to humidity, accidents, the use of steam, bleach, or any caustic abrasive, or solvent based cleaners, alterations or normal wear and tear upon the blinds are not covered by this warranty. Cord wear shall be considered as normal wear and tear. **Avalon Faux Wood** blinds are manufactured with PVC foam and contain no lead additives. Variations in grain and texture may appear randomly in slats, valance and bottom rail. Slight variations in color, as well as minimal warping may also occur. These are all natural occurring tendencies when dealing with PVC foam products and are considered acceptable. Returns for the above-mentioned reasons are not warranted.

The obligation of CACO's manufactured products and its distributors is limited to repair or replacement of the blinds or components found to be defective, at our option, provided the blinds are returned to an authorized CACO dealer or distributor and accompanied by "proof of purchase". CACO is not responsible for any shipping or labor costs associated for measuring, removing and re-installing blind from installed windows or fabricating alterations.

This warranty is exclusive and in lieu of all other obligations, liabilities, or warranties. In no event shall **CACO** be liable or responsible for incidental or consequential damages, or for any other direct or indirect damage, loss, cost, expense or fee. This warranty gives you specific rights, and you may also have other rights, which vary from state to state.

Cordless Fast Faux

Standard Features

- Available in two styles: Custom or Express
- 2" Steel "low-profile" head rail
- 2" PVC foam standard rectangular bottom rail
- 2" Flat PVC foam 3mm slats (500 hour)
- 3 1/4" Crown PVC foam valance with groove for hidden plastic installation clip
- Single blinds only (no 2 or 3 under one head rail) multiple blinds must be butted together
- Custom returns available
- Allowances Blind width inside mount
- Easy operating wand tilter
- Braided ladder is 44mm
- Steel box brackets have a hinged face
- Standard controls only -tilt left
- All standard freight policies apply
- Blinds may raise up to 1" when completely lowered
- When blinds are completely raised the stack may drop up to 3"
- 1-Year limited warranty on head rail and components.
- 5 -year limited warranty on valance, slats and bottom rail.

Specification	Custom Cordless Fast Faux	Express Cordless Fast Faux
Customize Width	Yes	Yes
Custom Length	Yes	No
Available Colors	FF02 White & FF03 Antique white	FF02 White only
Minimum Width	18"	18"
Minimum Length	36"	48"
Maximum Width	72"	72"
Maximum Length	72" (FF02 Antique White) or 84" (FF02 White Only)	84"
Custom Returns	No charge	\$8.50 retail

2" Custom Cordless Fast Faux

FF02 White		FF03 Antique White									
Width to:	24	28	32	36	42	48	54	60	66	72	
Length to:	48	129	137	140	152	176	192	210	226	242	272
	54	131	139	150	163	181	209	233	248	277	311
	60	138	144	155	176	195	214				
	66	140	152	165	188	210	239	259	280	311	350
	72	147	161	184	197	221	312	N/A	N/A	N/A	N/A
	84*	165	180	207	223	274					

* 84" only available in FF02 White

Options and Surcharges

- Customize width and length
- Custom returns at no charge
- Common valance \$6.83 per foot retail price

2" Express Cordless Fast Faux

FF02 White											
Width to:	24	28	32	36	42	48	54	60	66	72	
Length:	48	116	123	126	137	159	173	189	204	218	245
	54	118	125	134	147	163	188	N/A	N/A	N/A	N/A
	60	124	129	140	159	175	193	210	223	257	291
	66	126	137	148	169	189	N/A	N/A	N/A	N/A	N/A
	72	132	145	165	179	200	219	239	273	308	331
	84	156	171	195	212	261	287	N/A	N/A	N/A	N/A

Options and Surcharges

- Customize width only
- Custom returns \$8.50 retail price
- Common valance \$6.83 per foot retail price

Cordless Fast Faux Warranty

CACO, Inc. will extend a limited lifetime warranty on **Cordless Fast Faux**, a limited lifetime warranty on the head rail and components for **Cordless Fast Faux**; a limited 3-year warranty on **Cordless Fast Faux** operating cords, valance, slats and bottom rail.

Each blind is warranted to be free from defects in materials and workmanship to the original owner and limited to manually operated products only, provided that the blinds were: 1.) Installed in a residential dwelling. 2.) Properly installed in accordance with the installation instructions which accompany each blind to be installed in a window, door or other interior area for which they were intended. 3.) Maintained and cleaned in compliance with the manufacturer's recommendations.

Damage resulting from misuse, abuse, exposure to the elements, including but not limited to exposure to salty air, discoloration due to sunlight or passage of time, exposure to humidity, accidents, the use of steam, bleach, or any caustic abrasive, or solvent based cleaners, alterations or normal wear and tear upon the blinds are not covered by this warranty. Cord wear shall be considered as normal wear and tear. **Cordless Fast Faux** blinds are manufactured with PVC foam and contain no lead additives. Variations in grain and texture may appear randomly in slats, valance and bottom rail. Slight variations in color, as well as minimal warping may also occur. These are all natural occurring tendencies when dealing with PVC foam products and are considered acceptable. Returns for the above-mentioned reasons are not warranted.

The obligation of CACO's manufactured products and its distributors is limited to repair or replacement of the blinds or components found to be defective, at our option, provided the blinds are returned to an authorized CACO dealer or distributor and accompanied by "proof of purchase". CACO is not responsible for any shipping or labor costs associated for measuring, removing and re-installing blind from installed windows or fabricating alterations.

This warranty is exclusive and in lieu of all other obligations, liabilities, or warranties. In no event shall **CACO** be liable or responsible for incidental or consequential damages, or for any other direct or indirect damage, loss, cost, expense or fee. This warranty gives you specific rights, and you may also have other rights, which vary from state to state.

Available Aluminum Slat Colors & Limitations

1" Mini (6 gauge)	
014	Matte White
018	White
651	Simple White
652	Ivory
189	Artic Ice
665	Almost White
112	Light Alabaster
636	Vanilla
017	Alabaster
631	Fawn
611	Beige Satin
502	Wisteria
255	Garnet Red
566	Light Aqua
027	Federal Blue
259	True Blue
178	Imperial Jade
091	Transparent Aluminum
569	Gray AZ
693	Gray Sheen
626	Smokey Gray
662	Char Brown
606	Raw Umber
070	Gloss Black
012	Black

1" Mini (8 gauge)	
8014	Matte White
8651	Simple White
8652	Ivory
8665	Almost White
8112	Light Alabaster
8631	Fawn
8091	Transparent Aluminum
8569	Gray AZ
8662	Char Brown
8012	Black

2" Aluminum (8 gauge)	
2014	Matte White
2018	White
2665	Almost White
2112	Light Alabaster
2017	Alabaster
2631	Fawn
2091	Transparent Aluminum
2626	Smokey Gray
2606	Raw Umber
2070	Gloss Black

1" Jewel/Metallix (6 gauge)	
302	Brown Gold
673	Umber Bronze
672	Mercury Silver

Micro Mini (6 gauge)	
5014	Matte White
5018	White
5665	Almost White
5017	Alabaster
5631	Fawn
5091	Transparent Aluminum
5626	Smokey Gray
5012	Black

1" Alumiwood (6 gauge)	
754	Oak Wood
755	Walnut Wood

	Mounting Space		Size Limitations			
	Minimum	Flush	Minimum Width	Minimum Length	Maximum Width	Maximum Length
Micro (1/2") Cordless	3/4"	1-3/4"	18"	18"	96"	96"
1" Standard Cordless	3/4"	1-3/4"	18"	18"	96"	96"
1" Premium Cordless	7/8"	2"	24"	18"	84"	72"
1" Simple Touch Wand (installed behind headrail)	7/8"	3-3/4"	24"	12"	118"	120"
1" Simple Touch Wand (installed wall or frame)	7/8"	2-1/4"				
1" Simple Touch Remote (installed behind headrail)	7/8"	3-1/4"				
1" Simple Touch Remote (installed wall or frame)	7/8"	2"				
2" Cordless	1-1/2"	3"	24"	18"	72"	72"

Wand Specification	
Blind Drop	Wand length
= < 25"	12"
25 1/8" - 45"	18"
45 1/8" - 55"	24"
55 1/8" - 65"	30"
65 1/8" - 85"	40"
85 1/8" - 96"	50"

Micro, 1"	
# of hidden brackets	
Blind Width	Hidden Bracket Qty
8" - 36"	2
36 1/8" - 60"	3
60 1/8" - 85"	4
85 1/8" - 105"	5
105 1/8" - 118"	6

2" Blinds -		
# of box brackets & center supports		
Blind Width	Box Bracket qty	Center Support
< 36"	2	0
36" - 72"	2	1

• Standard bracket - box bracket

• Standard bracket - hidden bracket.

Color Coordination Chart

Color Coordination Chart		Slats				Rails, valances, and brackets for different blinds							Ladder
		1"		1/2" (micro)		Standard cordless blinds				Premium cordless & Motorization blinds			
		2"				For micro & 1" blinds		For 2" blinds		For 1" blinds			
		6G	8G	6G	8G	1-1/2" headrail	Box bracket*	2" rails	Box bracket	Headrail	Valance insert	Bottom rail	
Standard Colors	Matte white	014	8014	5014	2014	15018	005	005	005	001	No Insert	018	004
	White	018	8018	5018	2018	15018	005	005	005	001	No Insert	018	004
	Simple White	651	8651	-	-	15018	005	-	-	001	No Insert	018	004
	Ivory	652	8652	-	-	15018	005	-	-	001	No Insert	018	004
	Arctic Ice	189	-	-	2189	15018	005	005	189	001	No Insert	018	004
	Almost White	665	8665	5665	2665	15665	065	065	065	002	No Insert	665	017
	Light Alabaster	112	8112	-	2112	15665	065	065	065	002	No Insert	665	017
	Vanilla	636	-	-	-	15636	100	-	-	002	636	636	017
	Alabaster	017	-	5017	2017	15665	112	112	112	002	No Insert	665	017
	Fawn	631	8631	5631	2631	15631	031	031	031	006	No Insert	631	005
	Beige Satin	611	-	-	-	15611	031	-	-	008	No Insert	611	005
	Wisteria	502	-	-	-	15502	005	-	-	026	502	502	231
	Garnet Red	255	-	-	-	15255	233	-	-	020	255	255	255
	Light Aqua	566	-	-	-	15566	005	-	-	014	566	566	374
	Federal Blue	027	-	-	-	15027	017	-	-	028	027	027	027
	True Blue	259	-	-	-	15259	017	-	-	091	259	259	025
	Imperial Jade	178	-	-	-	15178	061	-	-	091	178	178	178
	Transparent Aluminum	091	8091	5091	2091	15091	034	034	034	091	No Insert	091	022
	Gray AZ	569	8569	-	-	15569	026	-	-	091	No Insert	569	022
	Gray Sheen	693	-	-	-	15569	281	-	-	091	No Insert	693	022
Smoky Gray	626	-	5626	2626	15626	026	026	026	091	626	626	022	
Char Brown	662	8662	-	-	15662	062	-	-	025	No Insert	662	662	
Raw Umber	606	-	-	2606	15012	233	033	233	025	No Insert	012	012	
Gloss Black	070	-	-	2070	15012	233	033	233	025	No Insert	012	012	
Black	012	8012	5012	-	15012	233	-	-	025	No Insert	012	012	
Alumi wood	Oak Wood	754	-	-	-	15754	233	-	-	011	754	754	302
	Walnut Wood	755	-	-	-	15755	233	-	-	012	755	755	007
Metallix & Jewel	Brown Gold Jewel	302	-	-	-	15611	031	-	-	091	302	611	302
	Mercury Silver	672	-	-	-	15091	034	-	-	091	672	091	022
	Umber Bronze	673	-	-	-	15662	233	-	-	012	673	662	662

- The color of the lift cord is white.
- The color of 1-1/2" headrail end cap is clear.
- For the 1-1/2" headrail, the standard mounting bracket is a hidden bracket. A box bracket is available upon request without additional charge.

1" Standard Cordless

Standard 6 Gauge – Standard Colors

Width to:	23"	26"	29"	32"	36"	40"	44"	48"	52"	57"	62"	67"	72"
Length to: 42"	112	118	124	127	136	145	154	162	168	177	186	192	201
48"	118	124	127	136	145	156	165	168	174	189	195	213	218
54"	124	127	136	139	156	165	171	177	186	201	213	221	233
60"	127	136	139	154	165	171	177	186	192	216	221	236	245
66"	130	139	154	162	171	177	186	195	204	227	236	245	257
72"	139	145	156	165	174	186	192	201	213	233	239	248	260
84"	145	156	165	171	183	192	204	216	227	245	257	275	286
90"	154	162	171	183	189	201	216	227	239	257	275	286	301
96"	162	168	177	186	201	216	227	239	251	275	289	304	319

Standard 8 Gauge

Width to:	23"	26"	29"	32"	36"	40"	44"	48"	52"	57"	62"	67"	72"
Length to: 42"	130	137	144	147	158	168	178	189	195	206	216	223	233
48"	137	144	147	158	168	182	192	195	202	219	226	247	254
54"	144	147	158	161	182	192	199	206	216	233	247	257	271
60"	147	158	161	178	192	199	206	216	223	250	257	274	285
66"	151	161	178	189	199	206	216	226	237	264	274	285	298
72"	161	168	182	192	202	216	223	233	247	271	278	288	302
84"	168	182	192	199	213	223	237	250	264	285	298	319	333
90"	178	189	199	213	219	233	250	264	278	298	319	333	350
96"	189	195	206	216	233	250	264	278	291	319	336	353	370

* 1" Standard cordless blind is available up to 72" width or 96" length.

* Blind ladder will be color coordinated, but inner lift cord will be white.

* Any orders with a product over 90" width will have an additional oversized fee. See full shipping policy for details.

Standard Features

- Standard Cordless Module*
- 1" wide .006 gauge slats (standard)
- 1" wide .008 gauge slats (optional)
- 1" X 1-1/2" steel head rail
- Endcap Color Clear
- Color coordinated C-shape bottom rail
- Wand tilt only (clear wand)
- Left tilt standard
- Inside Mount 1/2" deduction
- Hidden Bracket (standard)
- Box Bracket (optional)
- Limited Lifetime Warranty
- For Color availability see page 19

Size Limitations

- Minimum width 18"
- Maximum width 72"
- Minimum length 18"
- Maximum length 96"
- Minimum mounting space is 3/4"
- Minimum flush mount is 1-3/4"

**Please note due to the nature of the standard cordless module additional effort may be required when raising and lowering to maintain a level blind compared to the premium module.*

Surcharges

- Metallix/Jewel Color (6 gauge only) - 15%
- AlumiWood Color (6 gauge only) - 45%
- AlumiWood Real Wood Wand - \$13



Standard Cordless Headrail



Hidden Bracket (standard)



Box Bracket (optional)



Standard Cordless Module*

1" Premium Cordless

Premium 6 Gauge – Standard Colors

Width to:	26"	29"	32"	36"	40"	44"	48"	52"	57"	62"	67"	72"
Length to: 42"	148	165	180	202	224	249	273	292	313	337	353	369
48"	154	168	189	211	236	261	279	298	325	345	373	387
54"	156	177	192	223	245	267	288	310	337	363	382	402
60"	165	180	207	232	251	273	297	316	351	372	397	413
66"	168	195	216	238	257	282	306	328	363	387	406	425
72"	174	198	218	241	266	288	311	337	369	390	409	428

Premium 8 Gauge

Width to:	26"	29"	32"	36"	40"	44"	48"	52"	57"	62"	67"	72"
Length to: 42"	177	198	216	243	269	299	328	351	376	404	423	443
48"	184	202	227	253	283	314	335	358	390	415	448	464
54"	188	213	230	267	294	321	345	372	404	436	459	482
60"	198	216	248	278	301	328	356	379	422	446	477	496
66"	202	234	259	285	308	338	367	393	436	464	487	510
72"	209	237	262	289	319	345	374	404	443	468	491	514

* 1" Premium cordless blind is available up to 72" width or 72" length.
 * Blind ladder will be color coordinated, but inner lift cord will be white.

Standard Features

- Premium Cordless Module with self-leveling control
- 1" wide .006 gauge slats (standard)
- 1" wide .008 gauge slats (optional)
- 1-1/2" X 1-3/4" aluminum head rail
- Endcap Color Coordinated
- Color coordinated C-shape bottom rail
- Wand tilt only (clear wand)
- Left tilt standard
- Inside Mount 1/2" deduction
- Hidden Bracket only
- Clear Lift Handle included
- Limited Lifetime Warranty
- For Color availability see page 19

Size Limitations

- Minimum width 24"
- Maximum width 72"
- Minimum length 18"
- Maximum length 72"
- Minimum mounting space is 7/8"
- Minimum flush mount is 2"

Surcharges

- Metallix/Jewel Color (6 gauge only) - 15%
- AluminWood Color (6 gauge only) - 45%
- AlumiWood Real Wood Wand - \$13



Premium Cordless Headrail



Hidden Bracket



Premium Cordless Module



Lift Handle

1" Motorized

1" Motorized Blinds Base Price – (For full blind price add motor surcharge to base)

Width to:	26"	29"	32"	36"	40"	44"	48"	52"	57"	62"	67"	72"	82"	92"	102"	112"	118"
Length to:																	
42"	118	124	127	136	145	154	162	168	177	186	192	201	221	239	260	278	298
48"	124	127	136	145	156	165	168	174	189	195	213	218	239	251	283	301	319
54"	127	136	139	156	165	171	177	186	201	213	221	233	251	275	301	319	345
60"	136	139	154	165	171	177	186	192	216	221	236	245	272	289	319	342	363
66"	139	154	162	171	177	186	195	204	227	236	245	257	286	307	342	363	396
72"	145	156	165	174	186	192	201	213	233	239	248	260	301	337	360	387	
78"	156	165	171	183	192	204	216	227	245	257	275	286	316	345	384		
84"	162	171	183	189	201	216	227	239	257	275	286	301	337	360			
90"	168	177	186	201	216	227	239	251	275	289	304	319	351	387			
96"	174	186	192	216	227	239	251	272	295	310	334	345	378	410			
102"	183	192	201	221	239	248	263	283	304	325	345	360	402				
108"	189	195	213	233	245	260	278	289	316	340	354	378	413				
114"	192	204	218	239	251	272	286	301	334	351	372	396					
120"	201	216	227	245	260	283	298	310	345	363	387						

* Any orders with a product over 90" width will have an additional oversized fee. See full shipping policy for details.

Standard Features

- Simple Touch Rechargeable Battery Pack
- 1" wide .006 gauge slats
- 1" X 1-3/4" steel head rail
- Endcap Color Coordinated
- Color coordinated C-shape bottom rail
- Inside Mount 1/2" deduction
- Heavy Duty Brackets & screws provided
- Limited Lifetime Warranty on Blind
- 5 Year Warranty on motors and remote
- For Color availability see page 19

Size Limitations

- Minimum width 24"
- Maximum width 118"
- Minimum length 12"
- Maximum length 120"
- Maximum 56 sqft
- Minimum mounting space is 7/8"
- Minimum flush mount Wand Remote:
 - Battery pack installed behind blind 3-3/4"
 - Battery installed on wall/frame 2-1/4"
- Minimum flush mount 15-Channel Remote:
 - Battery pack installed behind blind 3-1/4"
 - Battery installed on wall/frame 2"

Surcharges

- 8 gauge slat - 20% surcharge
- Metallix/Jewel Color - 15% surcharge
- AluminWood Color - 45% surcharge

Simple Touch Wand Features

- Wand control will be color coordinated
- Wand is clear and white cord will be visible inside
- Standard length is half of the blind drop
- Minimum Length is 12"
- Maximum Length is 60"
- Control on Right standard
- Wand control only, remote control not available
- Wand will be programmed with the upper and lower limits

Simple Touch Wireless Remote Features

- 15 Channel Control Available
- At least 1 remote required per order
- Remote will be programmed with the upper and lower limits, please designate blind channels on your order.
- "0" on the remote will control all blinds as a group

Motor Surcharges

Wand Control Motor + Battery Pack	\$354 Retail
Remote Control Motor + Battery Pack	\$472 Retail

Optional Surcharges

15-Channel Remote (Remote Motor Only)	\$111 Retail
Additional Battery Packs	\$140 Retail
USB Wall Adapter (Power Block+80" USB-C)	\$30 Retail
Power Extension Cord (118")	\$22 Retail
Power Adapter (70")	\$59 Retail
Solar Panel	\$317 Retail

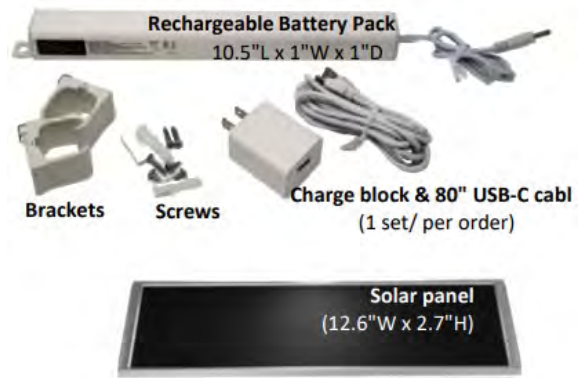

Simple Touch Motor Features

- For pricing add motor surcharge to base
- Power Source – Simple Touch Rechargeable Battery Pack which can be installed behind the headrail, the wall or window frame, however it is intended for indoor use and must be kept away from sunlight. Additionally, the only color available is white.
- 1 USB wall adapter and 80" USB-C charge cord will be provided with each order.
- Battery Pack can also be powered directly from a wall plug by using the power adapter, instead of recharging the battery pack.
- Optional solar panel available.
- Blind will automatically be programmed with the upper and lower limits

2" & Micro (1/2") Cordless

2" Standard

Width to:	26"	29"	32"	36"	40"	44"	48"	52"	57"	62"	67"	72"
Length to:												
42"	174	196	223	244	263	283	303	316	347	363	385	402
48"	182	207	236	258	278	297	313	332	366	385	406	427
54"	192	220	245	269	289	313	326	348	382	407	428	450
60"	202	227	258	280	304	325	345	368	402	424	449	471
66"	210	241	266	294	317	337	363	382	418	443	468	493
72"	221	245	276	304	328	353	376	397	437	465	490	515
84"	238	267	300	328	354	381	406	431	474	503	533	559

2" Standard with Cloth Tape

Width to:	26"	29"	32"	36"	40"	44"	48"	52"	57"	62"	67"	72"
Length to:												
42"	209	236	267	292	315	340	363	379	416	436	462	482
48"	218	248	283	310	333	356	376	399	439	462	487	512
54"	230	264	294	322	347	376	391	418	459	489	514	540
60"	243	273	310	337	365	390	415	441	482	508	539	565
66"	252	289	319	353	381	404	436	459	501	531	562	592
72"	266	294	331	365	393	423	452	477	524	558	588	618
84"	285	321	360	393	425	457	487	517	569	604	639	671

* Blind ladder will be color coordinated, but inner lift cord will be white.

Standard Features

- 2" wide .006 gauge slats
- 2" X 2" steel head rail
- 2-Slat Standard Valance
- 1/2" deduction on inside mount
- All interior lift cords are white
- Wand tilt only (clear wand)
- Cordless with no lift handle included
- Limited Lifetime Warranty
- For Color availability see page 19

Cloth tape available in 6 colors:

- 510 White
- 511 Duck White
- 512 Fawn
- 513 Dark Beige
- 514 Gray
- 524 Black

Size Limitations

- Minimum width 24"
- Maximum width 72"
- Minimum length 18"
- Maximum length 72"
- Minimum mounting space is 1 1/2"
- Minimum flush mount is 3"

Micro (1/2")

Width to:	23"	26"	29"	32"	36"	40"	44"	48"	52"	57"	62"	67"	72"	82"	92"	96"
Length to:																
42"	149	155	165	170	193	204	214	223	235	255	269	282	297	326	354	390
48"	155	165	173	182	205	218	226	241	251	276	289	306	319	351	381	425
54"	165	173	183	193	218	230	242	254	266	294	309	326	341	379	406	458
60"	170	182	195	201	226	241	255	269	282	310	329	348	366	404	440	489
66"	183	193	204	217	239	254	269	285	301	332	350	369	388	431	471	523
72"	192	201	214	224	251	266	285	301	317	350	369	390	412	458	500	554
78"	196	210	221	235	263	282	300	317	334	369	390	412	434	483	528	585
84"	204	218	232	245	276	294	314	332	350	388	410	433	458	508	555	617
90"	210	226	242	254	286	307	328	348	369	404	431	458	481	536	585	652
96"	220	235	249	264	301	320	341	365	385	425	452	480	503	564	616	685

* Blind ladder will be color coordinated, but inner lift cord will be white.

* Any orders with a product over 90" width will have an additional oversized fee. See full shipping policy for details.

Standard Features

- 1/2" wide .008 gauge slats
- 1" X 1 1/2" steel head rail
- 2-Slat Standard Valance
- 1/2" deduction on inside mount
- All interior lift cords are white
- Wand tilt only (clear wand)
- Cordless with no lift handle included
- Limited Lifetime Warranty
- For Color availability see page 19

Size Limitations

- Minimum width 18"
- Maximum width 96"
- Minimum length 18"
- Maximum length 96"
- Minimum mounting space is 3/4"
- Minimum flush mount is 1 3/4"

Warranty

CACO, Inc. will extend a limited lifetime warranty on Aluminum blinds, a limited lifetime warranty on blinds, cord and cord locks and a limited 5 year warranty on battery motors and wands. Each blind is warranted to be free from defects in materials and workmanship to the original owner, provided that the blinds were properly installed in a window, door or other interior area for which they intended, maintained and cleaned with the manufacturer recommendations.

Damage resulting from misuse, abuse, exposure to the elements, including but not limited to exposure to salty air, discoloration due to sunlight or passage of time, exposure to humidity, accidents, the use of steam, bleach, or any caustic abrasive, or solvent based cleaners, alterations or normal wear and tear upon the blinds are not covered by this warranty. Cord wear shall be considered as normal wear and tear. Some fading or reduction in color intensity may occur and should not be deemed defective. Returns for the above-mentioned reasons are not warranted.

The obligation of CACO's manufactured products and its distributors is limited to repair or replacement of the blinds or components found to be defective, at our option, provided the blinds are returned to an authorized CACO dealer or distributor and accompanied by "proof of purchase". CACO is not responsible for any shipping or labor costs associated for measuring, removing and re-installing blind from installed windows or fabricating alterations.

This warranty is exclusive and in lieu of all other obligations, liabilities, or warranties. In no event shall **CACO** be liable or responsible for incidental or consequential damages, or for any other direct or indirect damage, loss, cost, expense or fee. This warranty gives you specific rights, and you may also have other rights, which vary from state to state.

Styles & Features

Flat Fold Cordless (Standard)

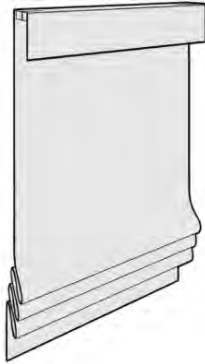

- Mounted on 1 1/2" x 3/4" wood headrail.
- Includes 6" front valance
- Minimums: Based on Pattern
- Maximums: Based on Pattern

Waterfall Cordless



- Mounted on 1 1/2" x 3/4" wood headrail.
- Includes 6" front valance
- Minimums: Based on Pattern
- Maximums: Based on Pattern

Flat Fold (Loop Control)

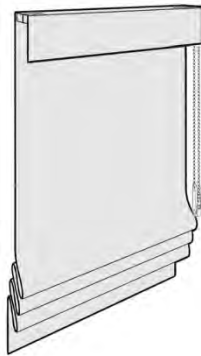

- Mounted on 1 1/2" x 3/4" or 2 1/2" x 3/4" wood headrail based on size.
- Includes 6" front valance
- Metal Bead Chain Only
- Minimums: Width - 18" Height - 24"
- Maximums: Width - 96" Height - 96"

Waterfall (Loop Control)



- Mounted on 1 1/2" x 3/4" or 2 1/2" x 3/4" wood headrail based on size.
- 4" back valance
- Controls hidden behind shade
- Metal Bead Chain Only
- Minimums: Width - 18" Height - 24"
- Maximums: Width - 96" Height - 96"

Hobbled (Loop Control)



- Mounted on 1 1/2" x 3/4" or 2 1/2" x 3/4" wood headrail based on size.
- Includes 6" valance
- Hobble Shade retains Flat Fold Pleats in lowered position
- Metal Bead Chain Only
- Minimums: Width 18" Height - 24"
- Maximums: Width - 96" Height - 96"

Flat Fold Motorized

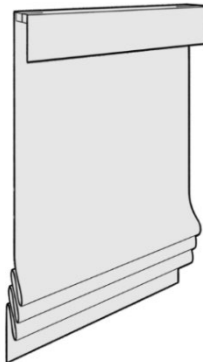

- Mounted on 1 1/2" x 3/4" wood headrail.
- Includes 6" front valance
- Minimums: Based on Pattern
- Maximums: Based on Pattern

Waterfall Motorized



- Mounted on 1 1/2" x 3/4" wood headrail.
- Includes 6" front valance
- Minimums: Based on Pattern
- Maximums: Based on Pattern

Measuring and Headrail options

Measuring Instructions

Inside Mount

- Measure inside width across at the top, middle and bottom of the window. Use the narrowest measurement when ordering. The factory will take a 1/4" deduction from each side for operational clearance (1/2" total).
- Measure inside height at the top and bottom. No deductions are taken from length measurements.
- L-Shaped bracket will be provided for installation.
- **Note:** Finished shade length may not be exactly as specified if exact dimension falls in the middle of a wide slat. Length tolerance of +/- 1"

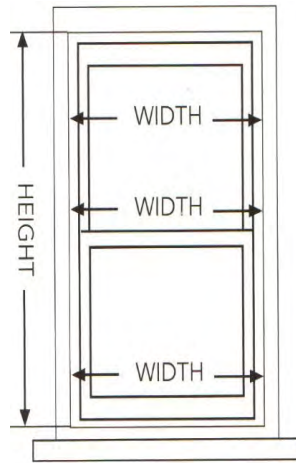

Outside Mount

- Measure exact finished width of shade. It is recommended that 3" be added to shade width for standard overlap.
- Measure exact finished length of shade. It is recommended that 1" - 1 1/2" be added to shade length for a standard shade.
- No deductions are taken for outside mount measurements.
- Side returns included.
- Valance width will be approximately 1" wider than ordered width.
- **Note:** Finished shade length may not be exactly as specified if exact dimension falls in the middle of a wide slat. Length tolerance of +/- 1"

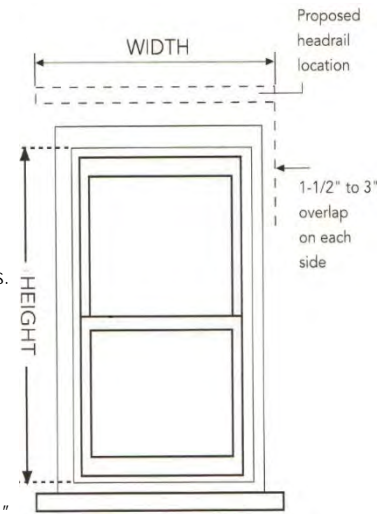

Two Shades on Headrail

- Shades can be mounted on one headrail for an additional surcharge.
- Flat Fold and Waterfall Styles only
 - Charged as individual shades
 - Available in Cordless & Loop Control
 - Loop mechanisms and must be ordered on opposite ends. (L/L, L/R, R/R, cannot be ordered R/L)
 - Minimum width 24"
 - Maximum shade size 102"
 - Valance maximum width without railroading is 96"

Measuring 2 on 1 Headrail:

- Measure width of area shade is to cover
- Factory will allow a minimum of 1/2" between shades for Operating clearance.
- Total width of all shades must equal total headrail width.
- Measure length using standard inside/outside mount procedures
- For patio doors, measure length to within 1" of the floor from top of shade
- Cords should be on outside edges of shades.
- Wall installation is recommended

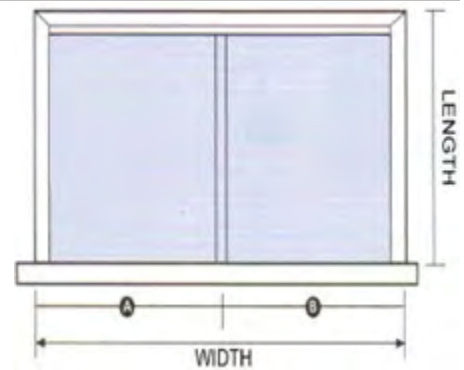

Stacking Dimensions

- All shades fully lifted stack to an average of 8"-10"
- Thickness of stack varies with different material weave.

	Flat Fold & Waterfall		Hobbled	
	Approx. Height	Approx. Thickness	Approx. Height	Approx. Thickness
24"	7.5"	1.5"	8.5"	2.5"
48"	7.5"	2.5"	8.5"	3"
72"	7.5"	3.5"	8.5"	3.5"
96"	8"	4.5"	9"	4.5"

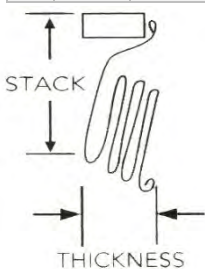

*Stacking averages:
Actual height may vary approx. +/-1"

Headrail Options

Headrail Dimensions	Headrail Dimensions		Minimum Depth Requirements			Profile
	Depth	Height	Depth	Flush Mount	Outside mount	
Cordless	1 1/2"	3/4"	1 1/2"	3"	2" of Flat Surface	
Motorization			1 1/2"	2 1/2"	2" of Flat Surface	
Slim Loop Control	1 1/2"	3/4"	1 1/2"	2 1/2"	2" of Flat Surface	
Standard Loop Control	2 1/2"	3/4"	2 1/2"	3 1/2"	2" of Flat Surface	

Shade option and limitation charts

Shade Style Options All Patterns		Styles										
		Flat Fold	Waterfall	Hobbled	1/2" Edge Binding	2 1/2" Edge Binding	Motorization	Cordless	Loop Control	Privacy Liner	Blackout Liner	2-on-1 Headrail
Styles	Flat Fold	Y			Y	Y	Y	Y	Y	Y	Y	Y
	Waterfall		Y		Y	Y	Y	Y	Y	Y	Y	Y
	Hobbled			Y	Y	Y	N	N	Y	Y	Y	N
Upgrades	1/2" Edge Binding	Y	Y	Y	Y	N	Y	Y	Y	Y	Y	Y
	1 1/2" Edge Binding	Y	Y	Y	N	Y	Y	Y	Y	Y	Y	Y
	Cordless	Y	Y	N	Y	Y	N	Y	N	Y	Y	Y
	Loop Control	Y	Y	Y	Y	Y	N	N	Y	Y	Y	Y
	Privacy Liner	Y	Y	Y	Y	Y	Y	Y	Y	Y	N	Y
	Blackout Liner	Y	Y	Y	Y	Y	Y	Y	Y	Y	N	Y
	2-on-1 Headrail	Y	Y	N	Y	Y	Y	Y	Y*	Y	Y	Y
Cord Position	Cord Position	Y	Y	Y	Y	Y	N	N	Y	Y	Y	N
	Ext. Bracket	Y	Y	Y	Y	Y	Y	Y	Y	Y	Y	Y
	Hold Down Clips	Y	Y	Y	Y	Y	Y	Y	Y	Y	Y	Y

*2-on-1 shades ordered with Loop Control must be ordered with controls on opposite ends of each other (L/L, L/R, R/R only)

Shade Limitations		Minimum Width	Maximum Width	Minimum Height	Maximum Height
Styles	Flat Fold	18"	96"	24"	96"
	Waterfall	18"	96"	24"	96"
	Hobbled	18"	96"	24"	96"
Upgrades	1/2" Edge Binding	18"	96"	24"	96"
	1 1/2" Edge Binding	18"	96"	24"	96"
	Motorization	24"	See Motorization limit chart	36"	See Motorization limit chart
	Cordless	See Cordless limit chart	96"	24"	96"
	Privacy Liner	18"	96"	24"	96"
	Blackout Liner	18"	96"	24"	96"
	2-on-1 Headrail	24"	96"	24"	96"

Features and Surcharges

Standard Features

- Cordless Flat Fold or Cordless Waterfall are standard – other styles require surcharge
- 6" Standard Valance for Flat Fold
- Valance side returns on outside mount only
- Wood headrail 1 1/2" width
- Not available in Hobbled Shade

No Charge Options

- Hold down clips
- Extension Brackets
- Returns on outside mount shades. Returns are made to the side of the front or back valance. Square, camel colored Velcro will be provided to attach returns
- Optional Regular side returns for inside mount shades

Loop Chain Control

- Left or Right control positions
 - Not available with Cordless or Motorization.
- Only available in cord loop, not PVC loop
- Loop control cord available in Stainless or Bronze chain
- Compliant Tension device
- Minimum Width 24"
 - Maximum Height 120"
- 2 Wood headrail widths based on shade size:
 - 1 1/2" width Slim Loop Control Headrail will be used on shades up 72" x 72" except for patterns B2264, B2265, B3311 & B3312, where the maximum size is 60" X 60". This is an estimate and can vary based on pattern selected or shade size.
 - 2 1/2" width Standard Loop Control Headrail will be used on shades larger than 72" x 72" except for patterns B2264, B2265, B3311 & B3312, where the minimum size is 60" X 60". This is an estimate and can vary based on pattern selected or shade size.

Surcharges

- Hobbled Shade, Liner and Edge Banding subject to 30% surcharge
- Tile Cutouts \$8 surcharge per cut, must provide sketch with exact measurements for "in" and "up"
- Edge Banding
 - Available in 1/2" or 1 1/2" widths
 - Mitered corners for 1.5" edge banding
 - Color coordinated thread
 - Fabric sewn on left/right/bottom of shade body, except Flat Fold valance or Cordless shades are left/right only

1/2" Fabric Edge Banding:

Length	36"	48"	60"	72"	84"	96"	108"	120"
	54	61	69	77	85	97	107	116

1 1/2" Fabric Edge Banding (Mitered):

Length	36"	48"	60"	72"	84"	96"	108"	120"
	111	127	145	162	184	211	237	260

Edge Banding Colors	
Color	Number
White	001
Oyster	002
Navy	007
Caramel	048
Chocolate	033
Silver	039
Warm Gray	043
Vanilla	006

Privacy & Blackout Liners

- Lining is attached to the back of the shade.
- Liner surcharge is added to the price of the shade
- Privacy Liner: Allows sunlight to filter through.
- Blackout Liner: Opaque room darkening liner with exterior off white lining.
- Standard design for shades is with the liner color facing interior and white back facing the exterior or street. Shades can be ordered in reverse but need to be requested with the color facing the street.
- Lining is subject to wrinkling.
- 30% Surcharge for Hobbled Shade Liner.

Privacy Liner

	2294P-White	2290P-Cream	2291P-Teak							
	2277P-Natural	2273P-Gray								
Width to:	24"	30"	36"	42"	48"	60"	72"	84"	96"	
Length to: 36"	51	57	64	70	88	116	132	148	164	
42"	55	61	69	76	97	127	145	162	180	
48"	59	67	75	83	105	137	157	177	196	
54"	62	70	80	89	114	147	169	191	213	
60"	67	75	86	96	122	158	181	206	229	
66"	70	80	91	102	130	168	194	220	245	
72"	74	84	96	109	138	179	206	234	262	
78"	100	115	129	144	195	248	284	320	356	
84"	103	120	136	152	206	260	299	338	377	
90"	108	126	142	159	215	273	313	355	396	
96"	113	130	148	166	226	285	329	372	416	
102"	116	135	155	173	236	298	344	391	437	
108"	121	141	160	180	246	310	359	408	456	
114"	126	146	167	188	257	323	375	426	477	
120"	129	151	173	195	266	336	390	443	496	

Blackout Liner

	2294BO-White	2290BO-Cream	2291BO-Teak							
	2277BO-Natural	2273BO-Gray								
Width to:	24"	30"	36"	42"	48"	60"	72"	84"	96"	
Length to: 36"	61	70	79	88	108	141	162	182	204	
42"	65	77	86	96	119	155	179	202	225	
48"	70	83	94	106	129	168	194	220	247	
54"	76	89	101	114	141	182	211	239	269	
60"	81	95	108	122	151	195	227	258	290	
66"	86	102	115	131	162	209	243	277	311	
72"	90	108	123	140	173	222	260	296	333	
78"	117	137	157	177	238	300	349	396	443	
84"	122	144	165	186	251	317	368	418	469	
90"	128	150	173	195	264	333	387	441	496	
96"	134	158	181	205	277	350	407	464	521	
102"	139	164	189	215	289	366	427	487	547	
108"	145	171	197	224	302	382	446	509	573	
114"	149	178	205	234	315	398	464	532	599	
120"	155	184	213	243	328	414	485	555	625	

Motorization

- Available in Flat fold or Waterfall styles
- Wood headrail 1 1/2" width
- Not available in Loop Control or Hobbled Shade
- Motor has built-in rechargeable lithium battery, using charger DC264 (1.1 Nm motor) to recharge
- The average motor charge will last about six months with everyday use.
- Remote control (White Only) can operate up to 15 shades
- Designate left or right for charging lead to accommodate power source.
- Shades will be programed before shipping, so notes will need to be made on order form to designate what shades will be assigned to which channel(s).



Automate Motorization Price	
Automate 1.1 Nm Li-ion	
12V Motor	\$179 Net
Wall Charger 12V	\$25 Net
Paradigm 15 Channel	
Remote	\$48 Net
Pulse Hub	\$166 Net
Solar Panel	\$32 Net

Motorization Limitations for Dynasty Patterns		72" DROP (Max. Width)		96" DROP (Max. Width)	
Chart	Pattern Name	Without Lining	With lining	Without Lining	With lining
1	Beijin – Smoke / Storm	96"	84"	78"	60"
1	Cortina – Latte / Shale	96"	84"	78"	60"
1	Yunnan – Cloud / Stone	96"	84"	78"	60"
2	Lhasa – Noir / White Sand	90"	72"	66"	54"
2	Meteor – Leaf / Shadow / Snow	96"	96"	96"	72"
2	Ningxia – Graystone / Taupe / White	96"	90"	90"	66"
2	Prarie – Taupe / Snow	96"	84"	78"	60"
2	Techno – Cinder / Haze	96"	84"	78"	60"
3	Hampton – Bisque / Natural / Slate	96"	96"	96"	78"
3	Tibet – Flax / Sterling	96"	96"	96"	96"
4	Chelsea – Sand / Stone	96"	96"	96"	96"
4	Havana – Café / Hemp / Pearl / Silver	96"	96"	96"	96"
4	Sand Dune – Gray / Marble / Taupe / White	96"	96"	96"	96"
4	Seawave – Bark / Mushroom / Slate	96"	96"	96"	84"
5	Classic Braid – Chestnut / Natural / Silver	96"	96"	96"	96"
5	Comoros – Natural / Pale Gray	96"	96"	96"	96"
5	Crosswave – Sand / Sandal	96"	96"	96"	96"
5	Senegal – Dune / Ivory / Toast / Silver	96"	96"	96"	96"

Motorization Limitations for Galaxy Patterns		72" DROP (Max. Width)		96" DROP (Max. Width)	
Chart	Pattern Name	Without Lining	With lining	Without Lining	With lining
1	Zagoli Sienna	96"	84"	72"	60"
1	Argos	96"	84"	72"	60"
1	Kyoto – Frost / Russet	96"	96"	96"	96"
2	Mesabi White	90"	96"	84"	72"
2	Bamboo Harvest	84"	72"	60"	48"
2	Aris Wheat	96"	96"	96"	96"
2	Edessa Cream	96"	96"	96"	84"
3	Lulea Snow	96"	96"	96"	96"
4	Luxor – Chestnut / Sand / Silver Charm	96"	96"	96"	96"
4	Lyon – Chalk / Glacier / Taupe	96"	96"	96"	72"
4	Arroyo – Gray / Pale Smoke / Thunder	96"	96"	96"	96"
4	Essex – Late / Sage / Straw / White Cloud	96"	96"	96"	96"
4	Arroyo – Gray / Pale Smoke / Thunder	96"	96"	96"	96"
4	Essex – Latte / Sage / Straw / White Cloud	96"	96"	96"	96"
4	Lakeshore – Latte / Straw / White Sands	96"	96"	96"	96"
4	Sanoma – Caramel / Concrete / Rust / Sabds	96"	96"	96"	96"
4	Hudson – Flax / Pebble	96"	96"	96"	96"
4	Timmins – Cream / Fossil / Seal	96"	96"	96"	96"
4	Serenity Mist	96"	96"	96"	96"
4	Avedon	96"	96"	96"	96"
5	Kingston – Rice / Rock / Smoke	96"	96"	96"	96"
5	Giza – Midnight / Snow / Wheat	96"	96"	96"	96"
5	Chatou – Snow / Star / Stone	96"	96"	96"	96"
5	Dawson – Marble / Tea / White	96"	96"	96"	96"
5	Zaria – Mink / Silver White	96"	96"	96"	96"
5	Boras Snow	96"	96"	96"	96"
5	Amour Wheat	96"	84"	72"	60"
5	Bengall Sand	96"	96"	96"	96"
5	Goya – Dawn / Wheat	96"	96"	96"	96"
6	Moncton – Granite / Snow Gray / Snow White	96"	96"	96"	96"
6	Zeffa – Grayish White / Mushroom / White /	96"	96"	96"	96"
6	Kuwada – Cotton / Lava / Stone	96"	96"	96"	96"
6	Surroy – Amber / Pearl / Tea / Whiterock	96"	96"	96"	96"
6	Winnipeg – Cream / Silver	96"	96"	96"	96"

Dynasty Pattern Identification

Dynasty Patterns			
Chart Listed on Samples	Pattern Number	Pattern Name	Roman Shade Price Chart
1	B3205	Beijin Smoke	Dynasty 1
1	B3206	Beijin Storm	Dynasty 1
1	B3201	Cortina Latte	Dynasty 1
1	B3202	Cortina Shale	Dynasty 1
1	B3211	Yunnan Cloud	Dynasty 1
1	B3212	Yunnan Stone	Dynasty 1
2	B3311	Lhasa Noir	Dynasty 2
2	B3312	Lhasa White Sand	Dynasty 2
2	B3322	Meteor Leaf	Dynasty 2
2	B3321	Meteor Shadow	Dynasty 2
2	B3323	Meteor Snow	Dynasty 2
2	B3353	Ningxia Graystone	Dynasty 2
2	B3352	Ningxia Taupe	Dynasty 2
2	B3351	Ningxia White	Dynasty 2
2	B3341	Prarie Taupe	Dynasty 2
2	B3342	Prarie Snow	Dynasty 2
2	B3332	Techno Cinder	Dynasty 2
2	B3331	Techno Haze	Dynasty 2
3	BJ3406	Hampton Bisque	Dynasty 3
3	BJ3405	Hampton Natural	Dynasty 3
3	BJ3407	Hampton Slate	Dynasty 3
3	BJ3416	Tibet Flax	Dynasty 3
3	BJ3415	Tibet Sterling	Dynasty 3
4	BP3506	Chelsea Sand	Dynasty 3
4	BP3505	Chelsea Stone	Dynasty 4
4	J3517	Havana Café	Dynasty 4
4	J3515	Havana Hemp	Dynasty 4
4	J3516	Havana Pearl	Dynasty 4
4	J3518	Havana Silver	Dynasty 4
4	BP3504	Sand Dune Gray	Dynasty 4
4	BP3501	Sand Dune Marble	Dynasty 4
4	BP3503	Sand Dune Taupe	Dynasty 4
4	BP3502	Sand Dune White	Dynasty 4
4	BP3511	Seawave Bark	Dynasty 4
4	BP3512	Seawave Mushroom	Dynasty 4
4	BP3513	Seawave Slate	Dynasty 4
5	BJ3613	Classic Braid Chestnut	Dynasty 5
5	BJ3611	Classic Braid Natural	Dynasty 5
5	BJ3612	Classic Braid Silver	Dynasty 5
5	J3608	Comoros Natural	Dynasty 5
5	J3607	Comoros Pale Gray	Dynasty 5
5	J3602	Crosswave Sand	Dynasty 5
5	J3601	Crosswave Sandle	Dynasty 5
5	J3604	Senegal Dune	Dynasty 5
5	J3603	Senegal Ivory	Dynasty 5
5	J3606	Senegal Silver	Dynasty 5
5	J3605	Senegal Toast	Dynasty 5

Galaxy Pattern Identification

Galaxy Patterns			
Chart Listed on Samples	Pattern Number	Pattern Name	Roman Shade Price Chart
1	BB1001	Argos	Galaxy 1
1	BB1268	Kyoto Frost	Galaxy 1
1	BB1266	Kyoto Russet	Galaxy 1
1	BB1080	Zagoli Sienna	Galaxy 1
2	BB2780	Aris Wheat	Galaxy 2
2	BB2264	Bamboo Harvest	Galaxy 2
2	BB2090	Edessa Cream	Galaxy 2
2	BB2253	Mesabi White	Galaxy 2
3	BJ3403	Lulea Snow	Galaxy 3
4	BY4201	Arroyo Thunder	Galaxy 4
4	BY4202	Arroyo Gray	Galaxy 4
4	BY4203	Arroyo Pale Smoke	Galaxy 4
4	BJ4350	Avedon	Galaxy 4
4	PB4190	Essex Latte	Galaxy 4
4	PB4170	Essex Sage	Galaxy 4
4	PB4180	Essex Straw	Galaxy 4
4	PB4160	Essex White Cloud	Galaxy 4
4	PB4212	Hudson Flax	Galaxy 4
4	PB4210	Hudson Pebble	Galaxy 4
4	BJ4523	Serenity Mist	Galaxy 4
4	PB4102	Lakeshore Latte	Galaxy 4
4	PB4103	Lakeshore Straw	Galaxy 4
4	PB4101	Lakeshore White Sands	Galaxy 4
4	PB4250	Luxor Chestnut	Galaxy 4
4	PB4260	Luxor Sand	Galaxy 4
4	PB4270	Luxor Silver Charm	Galaxy 4
4	PB4383	Lyon Chalk	Galaxy 4
4	PB4373	Lyon Glacier	Galaxy 4
4	PB4363	Lyon Taupe	Galaxy 4
4	PP4703	Sanoma Caramel	Galaxy 4
4	PP4705	Sanoma Concrete	Galaxy 4
4	PP4706	Sanoma Ginger	Galaxy 4
4	PP4704	Sanoma Rust	Galaxy 4
4	PP4702	Sanoma Sands	Galaxy 4
4	PP4701	Sanoma Snow	Galaxy 4
4	PB4240	Timmins Cream	Galaxy 4
4	PB4220	Timmins Fossil	Galaxy 4
4	PB4230	Timmins Seal	Galaxy 4

Galaxy Patterns			
Chart Listed on Samples	Pattern Number	Pattern Name	Roman Shade Price Chart
5	BJ5525	Amour Wheat	Galaxy 5
5	BJ5240	Bengali Sand	Galaxy 5
5	BJ5514	Boras Sno	Galaxy 5
5	PB5480	Chatou Snow	Galaxy 5
5	PB5460	Chatou Star	Galaxy 5
5	PB5470	Chatou Stone	Galaxy 5
5	PY5510	Dawson Marble	Galaxy 5
5	PY5530	Dawson Tea	Galaxy 5
5	PY5520	Dawson White	Galaxy 5
5	PB5420	Giza Midnight	Galaxy 5
5	PB5430	Giza Wheat	Galaxy 5
5	PB5440	Giza Snow	Galaxy 5
5	PP5740	Kingston Rice	Galaxy 5
5	PP5730	Kingston Rock	Galaxy 5
5	PP5720	Kingston Smoke	Galaxy 5
5	JJ5010	Goya Dawn	Galaxy 5
5	JJ5050	Goya Wheat	Galaxy 5
5	PY5313	Zaria Mink	Galaxy 5
5	PY5311	Zaria Silver White	Galaxy 5
6	JP6874	Kuwada Cotton	Galaxy 6
6	JP6872	Kuwada Lava	Galaxy 6
6	JP6870	Kuwada Stone	Galaxy 6
6	JP6778	Moncton Snow White	Galaxy 6
6	JP6779	Moncton Snow Gray	Galaxy 6
6	JP6777	Moncton Granite	Galaxy 6
6	JP6813	Surroy Pearl	Galaxy 6
6	JP6811	Surroy Whiterock	Galaxy 6
6	JP6810	Surroy Amber	Galaxy 6
6	JP6812	Surroy Tea	Galaxy 6
6	PY6832	Winnipeg Cream	Galaxy 6
6	PY6830	Winnipeg Silver	Galaxy 6
6	JP6334	Zeffa White	Galaxy 6
6	JP6335	Zeffa Whitish Gray	Galaxy 6
6	JP6336	Zeffa Grayish White	Galaxy 6
6	JP6333	Zeffa Mushroom	Galaxy 6

Cordless Pattern Limitations

Cordless Limitations for Dynasty Patterns		Width		Length	
Chart	Pattern Name	Minimum	Maximum	Minimum	Maximum
1	Beijin – Smoke / Storm	19"	96"	24"	96"
1	Cortina – Latte / Shale	19"	96"	24"	96"
1	Yunnan – Cloud / Stone	19"	96"	24"	96"
2	Lhasa – Noir / White Sand	18"	96"	24"	96"
2	Meteor – Leaf / Shadow / Snow	18"	96"	24"	96"
2	Ningxia – Graystone / Taupe / White	19"	96"	24"	96"
2	Prarie – Taupe / Snow	19"	96"	24"	96"
2	Techno – Cinder / Haze	18"	96"	24"	96"
3	Hampton – Bisque / Natural / Slate	18"	96"	24"	96"
3	Tibet – Flax / Sterling	18"	96"	24"	96"
4	Chelsea – Sand / Stone	18"	96"	24"	96"
4	Havana – Café / Hemp / Pearl / Silver	18"	96"	24"	96"
4	Sand Dune – Gray / Marble / Taupe / White	18"	96"	24"	96"
4	Seawave – Bark / Mushroom / Slate	18"	96"	24"	96"
5	Classic Braid – Chestnut / Natural / Silver	22"	96"	24"	96"
5	Comoros – Natural / Pale Gray	18"	96"	24"	96"
5	Crosswave – Sand / Sandal	19"	96"	24"	96"
5	Senegal – Dune / Ivory / Toast / Silver	18"	96"	24"	96"

Cordless Limitations for Galaxy Patterns		Width		Length	
Chart	Pattern Name	Minimum	Maximum	Minimum	Maximum
1	Zagoli Sienna	19"	96"	24"	96"
1	Argos	19"	96"	24"	96"
1	Kyoto – Frost / Russet	19"	96"	24"	96"
2	Mesabi White	18"	96"	24"	96"
2	Bamboo Harvest	19"	96"	24"	96"
2	Aris Wheat	18"	96"	24"	96"
2	Edessa Cream	18"	96"	24"	96"
3	Lulea Snow	19"	96"	24"	96"
4	Luxor – Chestnut / Sand / Silver Charm	18"	96"	24"	96"
4	Lyon – Chalk / Glacier / Taupe	18"	96"	24"	96"
4	Arroyo – Gray / Pale Smoke / Thunder	18"	96"	24"	96"
4	Essex – Late / Sage / Straw / White Cloud	18"	96"	24"	96"
4	Arroyo – Gray / Pale Smoke / Thunder	18"	96"	24"	96"
4	Essex – Latte / Sage / Straw / White Cloud	18"	96"	24"	96"
4	Lakeshore – Latte / Straw / White Sands	18"	96"	24"	96"
4	Sanoma – Caramel / Concrete / Rust / Sabds	22"	96"	24"	96"
4	Hudson – Flax / Pebble	18"	96"	24"	96"
4	Timmins – Cream / Fossil / Seal	18"	96"	24"	96"
4	Serenity Mist	18"	96"	24"	96"
4	Avedon	18"	96"	24"	96"
5	Kingston – Rice / Rock / Smoke	18"	96"	24"	96"
5	Giza – Midnight / Snow / Wheat	19"	96"	24"	96"
5	Chatou – Snow / Star / Stone	18"	96"	24"	96"
5	Dawson – Marble / Tea / White	18"	96"	24"	96"
5	Zaria – Mink / Silver White	18"	96"	24"	96"
5	Boras Snow	18"	96"	24"	96"
5	Amour Wheat	18"	96"	24"	96"
5	Bengali Sand	18"	96"	24"	96"
5	Goya – Dawn / Wheat	18"	96"	24"	96"
6	Moncton – Granite / Snow Gray / Snow White	18"	96"	24"	96"
6	Zeffa – Grayish White / Mushroom / White / Whitish Gray	18"	96"	24"	96"
6	Kuwada – Cotton / Lava / Stone	18"	96"	24"	96"
6	Surroy – Amber / Pearl / Tea / Whiterock	18"	96"	24"	96"
6	Winnipeg – Cream / Silver	18"	96"	24"	96"

Dynasty Patterns Shade Price Charts

Dynasty 1

		Cortina		Yunnan						
		Beinin								
Width		24"	30"	36"	42"	48"	60"	72'	84"	96"
Length to:	36"	366	419	456	520	563	670	813	937	1136
	42"	378	432	472	538	582	695	843	970	1173
	48"	387	443	484	552	600	717	869	1000	1207
	54"	413	475	521	596	647	774	937	1078	1296
	60"	422	486	534	611	665	796	962	1110	1331
	66"	434	501	552	628	683	820	992	1145	1369
	72"	454	526	583	663	724	870	1053	1215	1449
	78"	465	538	598	680	744	895	1081	1248	1485
	84"	473	550	611	695	760	915	1106	1278	1520
	90"	500	582	649	738	808	975	1174	1356	1609
	96"	512	595	664	758	830	1000	1203	1389	1648
	102"	520	606	677	773	847	1020	1230	1419	1682
	108"	541	632	707	809	888	1071	1290	1490	1762
	114"	549	642	720	823	905	1092	1315	1520	1796
120"	557	654	733	839	922	1114	1341	1549	1831	

Dynasty 2

		Meteor		Ningxia		Prarie		Techno		
		Lhasa								
Width		24"	30"	36"	42"	48"	60"	72'	84"	96"
Length to:	36"	400	455	500	570	618	743	899	1037	1252
	42"	414	472	519	594	645	774	938	1080	1301
	48"	427	487	536	614	668	803	973	1121	1346
	54"	458	523	579	663	722	870	1051	1213	1448
	60"	469	539	596	682	746	899	1086	1253	1496
	66"	483	558	620	705	772	930	1125	1299	1546
	72"	507	587	654	746	817	989	1195	1381	1640
	78"	520	603	674	768	843	1021	1231	1423	1687
	84"	533	618	691	788	865	1050	1267	1464	1735
	90"	564	655	734	838	920	1116	1345	1555	1837
	96"	578	672	755	863	949	1148	1382	1598	1887
	102"	589	688	771	884	972	1178	1417	1639	1933
	108"	613	717	807	924	1019	1237	1487	1720	2026
	114"	624	731	824	945	1042	1265	1521	1761	2072
120"	636	745	841	965	1066	1294	1558	1802	2120	

Dynasty 3

		Tibet		Hampton						
Width		24"	30"	36"	42"	48"	60"	72'	84"	96"
Length to:	36"	414	474	521	597	648	778	942	1086	1306
	42"	433	494	546	626	680	818	990	1141	1367
	48"	446	513	568	651	710	855	1035	1192	1426
	54"	478	550	610	700	766	922	1112	1282	1528
	60"	493	569	632	725	794	958	1155	1333	1586
	66"	511	591	659	753	825	997	1203	1390	1649
	72"	534	621	693	794	872	1053	1272	1469	1740
	78"	550	640	718	821	903	1094	1319	1523	1802
	84"	566	659	739	847	932	1131	1362	1574	1860
	90"	596	696	783	895	987	1197	1440	1665	1962
	96"	614	718	808	926	1021	1237	1487	1719	2024
	102"	628	736	829	952	1051	1273	1532	1771	2083
	108"	651	765	864	992	1096	1330	1600	1850	2173
	114"	666	784	887	1018	1126	1367	1644	1902	2232
120"	681	801	908	1043	1155	1403	1688	1953	2292	

Dynasty 4

		Havana		Sand Dune		Seawave				
Width		24"	30"	36"	42"	48"	60"	72'	84"	96"
Length to:	36"	435	501	553	634	691	832	1005	1159	1389
	42"	458	526	583	670	732	881	1065	1229	1467
	48"	477	550	612	703	770	929	1122	1296	1543
	54"	508	587	655	753	825	997	1201	1387	1646
	60"	528	611	684	786	863	1045	1258	1454	1722
	66"	549	639	718	822	904	1095	1321	1526	1803
	72"	573	669	753	862	951	1152	1390	1607	1895
	78"	593	695	784	898	990	1204	1449	1675	1974
	84"	613	719	811	931	1028	1250	1506	1742	2050
	90"	645	757	856	981	1084	1318	1585	1834	2154
	96"	666	784	888	1019	1127	1369	1646	1904	2233
	102"	685	807	915	1052	1165	1417	1703	1971	2308
	108"	709	837	950	1093	1212	1475	1773	2052	2402
	114"	728	861	978	1126	1249	1523	1829	2118	2478
120"	747	884	1007	1159	1288	1570	1886	2185	2554	

Dynasty 5

		Comoros		Crosswave		Senegal				
Width		24"	30"	36"	42"	48"	60"	72'	84"	96"
Length to:	36"	502	582	651	748	822	995	1200	1390	1651
	42"	532	618	694	799	879	1065	1287	1487	1761
	48"	559	652	734	846	933	1133	1367	1582	1870
	54"	598	700	790	911	1006	1222	1472	1703	2007
	60"	626	733	831	958	1059	1289	1554	1797	2115
	66"	655	772	877	1008	1116	1359	1638	1897	2227
	72"	687	813	924	1063	1180	1439	1734	2008	2354
	78"	717	848	967	1113	1236	1510	1817	2105	2464
	84"	744	882	1008	1160	1290	1577	1898	2199	2573
	90"	783	931	1064	1224	1363	1666	2003	2321	2710
	96"	813	968	1107	1276	1421	1736	2087	2419	2821
	102"	840	1001	1148	1324	1475	1804	2167	2514	2929
	108"	872	1041	1197	1379	1539	1883	2263	2625	3056
	114"	899	1075	1236	1427	1592	1951	2344	2720	3165
120"	927	1108	1277	1474	1646	2018	2425	2813	3273	

* Any orders with a product over 90" width will have an additional oversized fee. See full shipping policy for details.

Galaxy Patterns Price Charts

Galaxy 1

		Argos	Kyoto	Zagoli Sienna						
		24"	30"	36"	42"	48"	60"	72"	84"	96"
Length to:	36"	323	368	399	454	493	585	712	821	1001
	42"	330	375	407	464	504	599	728	838	1019
	48"	334	380	413	471	513	609	740	852	1035
	54"	359	410	448	511	558	665	807	929	1122
	60"	363	415	454	518	566	675	819	943	1139
	66"	374	429	469	532	577	687	835	962	1159
	72"	394	454	500	568	617	738	896	1033	1240
	78"	400	461	508	577	627	751	910	1049	1258
	84"	404	467	514	584	635	761	922	1064	1274
	90"	429	497	549	625	681	818	988	1140	1361
	96"	436	505	558	637	694	831	1004	1158	1381
	102"	441	510	565	644	702	841	1016	1172	1397
	108"	461	536	595	679	743	891	1076	1242	1477
114"	465	541	601	687	751	902	1089	1257	1494	
120"	469	546	607	694	759	912	1101	1271	1510	

Galaxy 2

		Aris	Bamboo Harvest				Edessa Cream			
		24"	30"	36"	42"	48"	60"	72"	84"	96"
Length to:	36"	335	382	416	474	514	611	743	857	1043
	42"	343	391	426	486	528	628	764	879	1067
	48"	348	398	434	496	539	642	780	899	1089
	54"	375	430	471	539	587	701	850	980	1181
	60"	380	436	479	548	598	715	867	999	1203
	66"	390	450	495	563	611	731	887	1023	1229
	72"	412	477	527	600	654	784	952	1099	1315
	78"	420	486	538	612	667	801	970	1120	1338
	84"	425	493	546	621	678	815	987	1139	1360
	90"	452	525	583	664	726	874	1057	1220	1453
	96"	460	535	594	679	742	891	1076	1242	1478
	102"	466	542	603	689	753	905	1093	1262	1499
	108"	487	569	635	726	796	959	1157	1337	1585
114"	493	576	643	736	807	972	1173	1356	1607	
120"	498	582	651	745	818	986	1190	1375	1629	

Galaxy 3

		Lulea								
		24"	30"	36"	42"	48"	60"	72"	84"	96"
Length to:	36"	378	430	471	537	582	698	843	973	1171
	42"	392	446	489	559	606	727	879	1013	1216
	48"	403	459	505	578	628	754	911	1051	1259
	54"	431	493	545	623	678	816	983	1134	1354
	60"	442	507	561	642	700	843	1016	1172	1396
	66"	456	525	582	662	723	871	1052	1214	1443
	72"	477	552	614	700	766	925	1116	1289	1529
	78"	490	567	632	721	790	955	1150	1329	1574
	84"	501	581	648	739	811	982	1182	1366	1617
	90"	529	615	687	784	861	1043	1255	1450	1711
	96"	543	631	707	808	888	1073	1290	1490	1757
	102"	554	645	723	827	909	1100	1322	1528	1800
	108"	575	672	755	865	952	1153	1386	1603	1886
114"	586	685	771	883	974	1180	1418	1640	1929	
120"	597	698	787	902	995	1207	1451	1678	1971	

Galaxy 4

		Arroyo	Avedon		Essex	Hudson				
		Lakeshore	Luxor	Lyon						
		Sanoma	Serenity	Timmins						
		24"	30"	36"	42"	48"	60"	72"	84"	96"
Length to:	36"	421	481	530	606	659	791	958	1105	1329
	42"	439	502	554	635	692	831	1007	1160	1391
	48"	454	521	577	661	722	869	1052	1213	1451
	54"	486	559	620	711	778	937	1131	1305	1555
	60"	501	577	643	738	808	974	1176	1357	1615
	66"	519	601	670	766	840	1014	1225	1415	1679
	72"	542	630	705	807	886	1072	1295	1496	1773
	78"	559	651	730	835	918	1113	1342	1551	1835
	84"	574	670	752	861	948	1150	1387	1603	1895
	90"	606	708	796	911	1004	1218	1467	1695	1998
	96"	624	730	822	943	1039	1259	1515	1751	2061
	102"	639	748	844	969	1069	1296	1560	1803	2121
	108"	662	777	879	1010	1116	1355	1630	1885	2215
114"	677	796	902	1036	1146	1392	1675	1937	2275	
120"	692	815	924	1062	1176	1430	1720	1990	2335	

Galaxy 5

		Amour	Wheat	Bengali		Boras Snow				
		Chatou	Goya	Dawson	Kingston	Giza	Zaria			
		24"	30"	36"	42"	48"	60"	72"	84"	96"
Length to:	36"	448	515	569	652	712	857	1036	1197	1434
	42"	471	541	601	690	754	909	1100	1269	1515
	48"	490	566	631	724	794	959	1159	1338	1594
	54"	523	605	676	776	851	1029	1242	1433	1702
	60"	543	630	706	811	891	1079	1301	1502	1781
	66"	566	660	740	847	933	1130	1364	1577	1864
	72"	590	690	777	890	981	1191	1437	1662	1961
	78"	612	717	808	926	1023	1243	1498	1733	2042
	84"	632	741	838	961	1062	1293	1558	1802	2121
	90"	664	781	883	1013	1120	1363	1640	1897	2229
	96"	687	808	916	1053	1165	1415	1703	1969	2311
	102"	707	833	945	1087	1204	1465	1762	2039	2390
	108"	731	864	982	1130	1253	1526	1835	2123	2487
114"	751	888	1012	1164	1292	1575	1894	2193	2566	
120"	771	913	1041	1199	1332	1624	1953	2262	2645	

Galaxy 6

		Kuwada	Mocton		Surroy					
		Winnipeg	Zeffa							
		24"	30"	36"	42"	48"	60"	72"	84"	96"
Length to:	36"	516	600	672	772	848	1027	1241	1435	1707
	42"	547	637	716	824	907	1101	1329	1537	1821
	48"	575	672	758	873	963	1171	1414	1635	1933
	54"	617	722	816	940	1039	1263	1523	1761	2077
	60"	645	757	859	989	1095	1334	1607	1859	2189
	66"	676	797	906	1040	1153	1406	1695	1963	2305
	72"	709	839	955	1098	1219	1489	1794	2079	2438
	78"	739	876	999	1149	1277	1562	1881	2179	2552
	84"	767	911	1041	1199	1334	1632	1965	2277	2664
	90"	809	961	1100	1266	1409	1725	2074	2403	2807
	96"	840	1000	1145	1320	1470	1798	2161	2504	2923
	102"	868	1035	1187	1369	1526	1868	2245	2603	3035
	108"	901	1076	1237	1427	1593	1951	2345	2719	3167
114"	929	1111	1279	1476	1649	2021	2429	2817	3280	
120"	958	1146	1321	1525	1705	2091	2513	2915	3392	

* Any orders with a product over 90" width will have an additional oversized fee. See full shipping policy for details.

Material and Characteristics

- Designer Natural Shades are an aesthetic collection of natural woods, bamboos, jutes, grasses and reeds harvested from nature.
- Each season's harvests are a celebration of unique textures, colors and striations that develop in nature.
- Natural materials are subject to variances in color, grain, texture and warpage that are inherent qualities in all-natural fibers.
- These variances are not manufacturing defects. The beauty of Designer Natural Shades lies in the distinctive irregularities of the slats and reeds.

Color Variations

- Even though rigid quality standards are maintained, the factory cannot guarantee exact color matches in each of the collections.
- Variations in color are natural and will be especially visible in lighter colored fibers.
- Variations in color will occur and are not manufacturing defects.
- Over time, the color of Designer Natural Shades will soften in the sun, exposing the beauty in mild tones.
- To avoid color variations that may occur between dye lots, it is highly recommended that multiple shade orders of the same pattern be placed at one time. This will lower the possibility of color variation due to different paints and stains.
- CACO is not responsible for variances in color for orders of the same pattern ordered at different times.
- Availability of colors is subject to change without notice.

Stretching, Shrinking, Cracks

- Woven wood fabric can be affected by temperature and humidity changes, which can shrink the material.
- Shipping and handling may also cause a slight change in shade lengths.
- Note: Material stretching or shrinking may become more noticeable on inside mount shades where exact lengths are more critical.
- Bamboo matchsticks tend to stretch after installation.
- Finished edges of bamboo and large reeds may crack after cutting and assembly due to the inherent property of natural materials.
- Finished shade height may vary in exact dimension fails in the middle of a wide slat.
- Finished shade height may have a tolerance of + or - 1"

Ordering Process

Orders can only be accepted email or fax and submitted using the following order forms: Designer Natural Woven Wood Shade, or Hobbled Valance only. For your convenience, a copy is printed on the last pages of this book. You may also go to cacoinc.com and download a pdf on which your order may be entered, saved and emailed. When faxing it is important to note the number of pages of your order, including the cover sheet to ensure that no pages will be missing. Please fully complete the form, any omission of pertinent information will only delay your orders manufacturing time.

Changes

In the event that you wish to add to your original order, it is possible, as long as it is within 24 hours after the order was placed. You will be required to submit changes in writing and must be signed by a person of authority indicating the items you wish to add or change. No verbal requests can be made. You will need to refer to the original P.O. number and indicate clearly the additions or changes you're requesting. Addresses may not be changed after the 24 hours period.

Cancellations

Cancellations or changes require an immediate response and can only take within 24 hours of order submittal. You must first identify your P.O. number or side mark and then state the cancellation or change. Cancellations must be faxed or emailed in writing only, no verbal requests can be accepted.

Shipping and Handling

Before accepting any shipments, please examine each carton carefully. If shipment shows any signs of mistreatment or damage, i.e., wheel marks, crushed or bent cartons note this on the bill of lading and have the driver sign it and note damage. It is imperative that you count all cartons prior to signing the bill of lading; any shortages must be noted on the bill of lading with the driver's signature. Please open examine products upon receipt and notify CACO of any damages or losses within one week of receipt. We will require that photos of any damage be emailed to customerservice@cacoinc.com.

Defective Merchandise

All manufacturing defects must be reported within one week of receipt of shades. We require photos prior to the return of defective shades prior to repair or replacement.

Repair or Alterations

If a repair or alteration is needed, please contact CACO for more details prior to return for repair. Repairs should be carefully packaged. Products mishandled or received in poor condition will be returned back to the customer.

Warranty, Care and Maintenance

We are proud to offer a three-year warranty for components and one year for products to our customers. Each shade undergoes careful inspection before being sent out to our customers. Under normal and proper use, three-year limited warranty applies such shades are free from defects due to faulty workmanship or materials. This warranty is not applicable to accidents, alteration, abuse, misuse, misapplication or failure to follow instructions or defects due to faulty installation. For claims covered during the warranty period, product will be replaced or repaired free of charge.

Natural conditions such as color variance and fading due to sun exposure, slats / reed warpage from high humidity, as well as stretching and shrinking of shades due to temperature and humidity, are excluded from the warranty. This warranty does not cover liability for loss, damage or injury, direct or consequential, arising out of the use or inability to use the product. Warranty does not cover labor on location, service calls, reinstallation or expenses involved in shipping, packaging and returning merchandise unless authorized.

Care and Maintenance

Woven wood shades are easy to maintain and are extremely durable. Raising and lowering shades periodically aids in reduction of dust accumulation. Or simply vacuum with a soft brush attachment. In high traffic areas, you may want to scotch guard your shades with 3M Scotch Guard spray for added stain protection. The functional lifetime of the operation hardware is far greater than normally needed.

Features & Benefits

FEATURES & BENEFITS

- Honeycomb construction provides superior insulation and energy efficiency.
- No visible cords or cord holes reduces light leaks and adds to the fashionable appeal.
- Fabric available in wide widths to cover large expansive windows with no seams or overlap.
- 100% crisp polyester fabric repels dust and dirt and is easy to clean and maintain.
- Multiple design options and operating systems available to provide the perfect solution for the single homeowner to the busiest family.

FABRICS

Cellular Shades are built with beauty and your comfort in mind, featuring durable, low-maintenance fabrics and a broad spectrum of designer colors, neutrals, and bold hues including specialty fabrics like lux, slubs, crush and printed designs. Cellular Shades are among the most energy-efficient window coverings available. The insular property of cellular fabrics is attributed to its unique construction. The signature candlelight glow and handcrafted feel of the cellular fabric brings world-class elegance to your home, office or retail environment.

VERSATILITY

- Create unlimited custom lighting solutions with a full range of opacities
- Light Filtering fabrics feature rich, vibrant color
- Blackout fabrics offer extended light control and privacy

LIGHT FILTERING FABRICS

- Transmit filtered light with no view through the shade
- Provide moderate privacy
- Available in 3/4", 9/16" and 1 1/4" Single Cell, 7/16" Double Cell and 3/4" Cell-in-a-Cell Fabrics

BLACKOUT FABRICS

- Blocks 99% of outside light
- Provides complete privacy and light control
- Available in 3/4", 9/16" and 1 1/4" Single Cell

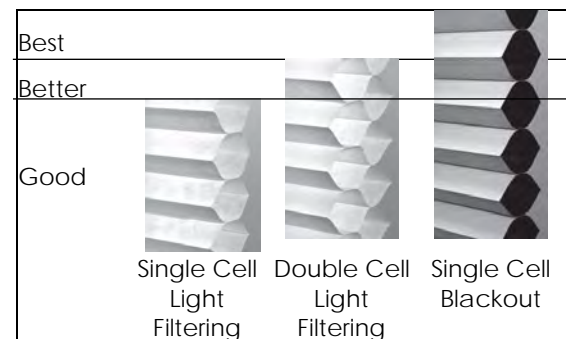

ENERGY EFFICIENCY

Cellular shades are among the most energy-efficient window coverings available. The insular property of cellular fabric is attributed to its unique cellular construction creating a barrier of chambers designed to reduce heat and the damaging effects of UV light. Our premium cellular fabrics are categorized into three simple levels of energy efficiency to help you maximize your budget and the comfort in your home.

Style Options

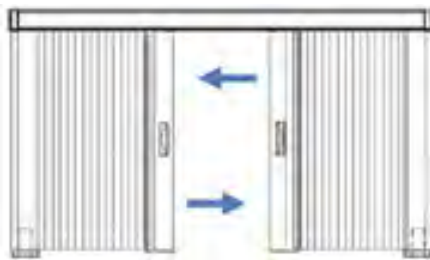
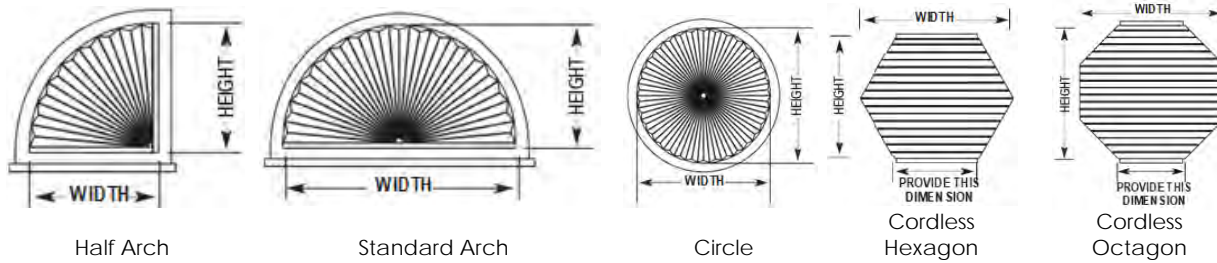
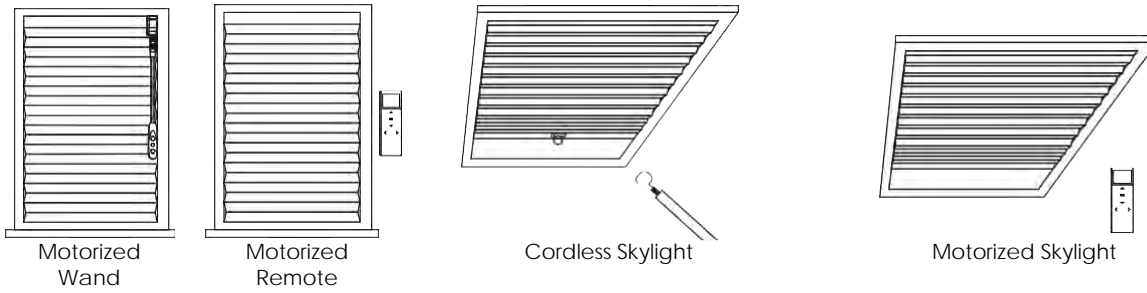

Slider - Center Split

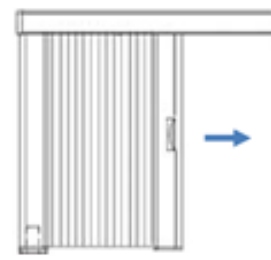

Slider - Side Stack

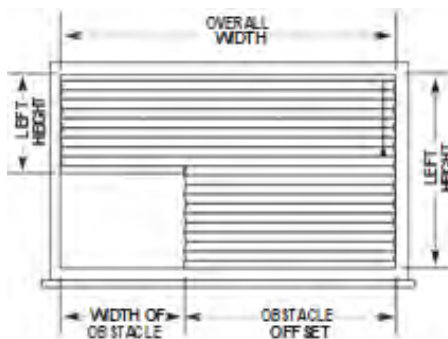

Cutouts

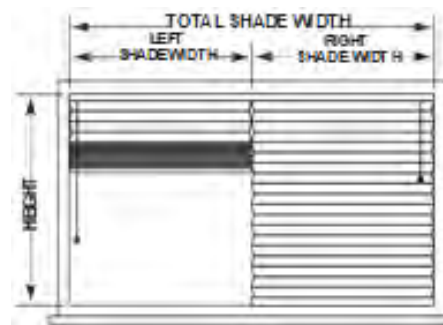

2-on-1 Headrail

Boone Collection Cellular Shades

Headrail and Stacking Chart



Cordless shades pictured for headrail and bracket comparison. Additional shade selections will vary from based on components needed for operation. Bottom rails and middle rails will match headrail sizes.

* 9/16" Classic headrail standard. 3/4" Modern upgrade available for \$6.50 net per shade.

* 3/4" Modern headrail standard. 9/16" Classic option available at no charge.

Cell Size	Headrail Size	Mount Type	Clutch	Clutch TDBU	Cordless	Cordless TDBU	Motorization
9/16" or 7/16"	Standard 9/16" Classic	Minimum Mounting Space	7/8"	7/8"	7/8"	7/8"	7/8"
		Minimum Flush Mount	2"	2"	2"	2"	2"
	Upgrade 3/4" Modern	Minimum Mounting Space	1/2"	1/2"	1/2"	1/2"	1/2"
3/4"	Optional 9/16" Classic	Minimum Mounting Space	7/8"	7/8"	7/8"	7/8"	7/8"
		Minimum Flush Mount	2 1/2"	2 1/2"	2 1/2"	2 1/2"	2 1/2"
	Standard 3/4" Modern	Minimum Mounting Space	1/2"	1/2"	1/2"	1/2"	1/2"
1 1/4"	Optional 9/16" Classic	Minimum Mounting Space	7/8"	7/8"	7/8"	7/8"	7/8"
		Minimum Flush Mount	2 1/2"	2 1/2"	2 1/2"	2 1/2"	2 1/2"
	Standard 3/4" Modern	Minimum Mounting Space	1/2"	1/2"	1/2"	1/2"	1/2"
		Minimum Flush Mount	2 5/8"	2 5/8"	2 5/8"	2 5/8"	2 5/8"

Headrail Bracket Quantity	
Shade Width	Quantity
7" - 36"	2
36.1" - 72"	3
72.1" - 96"	4
96.1" - 120"	5
120.1" - 144"	6

Continuous Cord Length	
Shade Height	Length
< 40"	2 feet
40" - 57.9"	3 feet
58" - 72.9"	4 feet
73" - 85.9"	5 feet
86" - 107.9"	6 feet
≥ 108"	8 feet

Stacking Chart: This includes headrail and bottom rail (for corded system)													R Value
Fabric Type	36" Drop	48" Drop	60" Drop	72" Drop	84" Drop	96" Drop	108" Drop	120" Drop	132" Drop	144" Drop			
	3/4" Single Cell	Light Filtering	3.26	3.39	3.52	3.68	3.82	3.95	4.11	4.25	4.40	4.55	3.8
Blackout		3.20	3.35	3.50	3.65	3.80	3.95	4.10	4.23	4.38	4.51	4.4	
Linen Print LF		3.39	3.55	3.71	3.86	4.02	4.18	4.34	4.49	4.66	4.81	3.6	
Linen Print BO		3.30	3.42	3.55	3.67	3.80	3.94	4.06	4.20	4.32	4.45	4.2	
Bamboo Print LF		3.26	3.39	3.52	3.68	3.82	3.96	4.13	4.26	4.41	4.56	3.8	
Bamboo Print BO		3.20	3.35	3.50	3.65	3.80	3.95	4.10	4.23	4.38	4.51	4.4	
Tweed Print LF		3.26	3.39	3.52	3.68	3.82	3.96	4.13	4.26	4.41	4.56	3.8	
Tweed Print BO		3.20	3.35	3.50	3.65	3.80	3.95	4.10	4.23	4.38	4.51	4.4	
Smooth LF		3.13	3.25	3.38	3.50	3.63	3.75	3.88	4.00	4.13	4.25	3.7	
Smooth BO		2.90	2.98	3.06	3.14	3.22	3.30	3.39	3.47	3.56	3.64	4.4	
LUX Linen LF		3.31	3.53	3.76	3.98	4.21	4.43	4.66	4.88	5.11	5.33	2.8	
Slub Woven LF		3.48	3.67	3.82	4.01	4.17	4.32	4.48	4.67	4.82	5.01	2.8	
Whisper Woven LF		3.23	3.36	3.46	3.57	3.68	3.80	3.90	4.02	4.14	4.25	2.7	
Sheer LF		3.38	3.54	3.72	3.87	4.04	4.18	4.33	4.48	4.65	4.80	2.2	
3/4" Cell-In-A-Cell	Light Filtering	4.32	4.74	5.16	5.58	6.01	N/A	N/A	N/A	N/A	N/A	4.3	
9/16" Single Cell	Blackout	4.14	4.51	4.88	5.25	5.62	N/A	N/A	N/A	N/A	N/A	4.7	
1-1/4" Double Cell	Light Filtering	2.88	3.13	3.38	3.68	3.88	4.18	4.38	4.70	4.88	5.20	3.5	
	Blackout	2.69	2.88	3.06	3.25	3.44	3.63	3.81	4.00	4.19	4.38	4.3	
	Linen Print LF	3.00	3.25	3.50	3.75	4.00	4.25	4.50	4.75	5.00	5.25	3.5	
	Slub Woven LF	3.13	3.42	3.71	4.00	4.29	4.58	4.88	5.17	5.46	5.75	2.8	
	Fire Retardant LF	2.80	3.01	3.18	3.35	3.52	3.69	3.86	4.04	4.21	4.38	3.5	
7/16" Double Cell	Fire Retardant BO	2.74	2.91	3.09	3.25	3.39	3.54	3.68	3.83	3.97	4.13	4.3	
1-1/4" Single Cell	Light Filtering	3.27	3.43	3.61	3.80	3.96	4.15	4.31	4.49	4.65	4.89	3.9	
7/16" Double Cell	Blackout	2.95	3.03	3.12	3.21	3.29	3.38	3.46	3.56	3.63	3.76	4.5	
9/16" Double Cell	Light Filtering	3.30	3.70	4.09	4.48	4.88	5.27	5.66	6.05	6.45	6.84	3.6	

to place an order call (800) 552-5278 or fax (866) 926-5836 or email customerservice@cacoinc.com

Standard Features, Surcharges and Size Limitations

Standard Features:

- Inside mount 1/4" standard deduction
- Color coordinated aluminum headrail and bottom rail
- Right control standard
- Standard Cordless module
- 9/16" Classic Headrail standard for 9/16" & 7/16" cell fabrics. 3/4" headrail available for \$24 per shade
Note only Simple Touch Wand and Fabric insert for Top Down Bottom Up shades available on 9/16" headrails.
- 3/4" Modern Headrail standard for 3/4" & 1 1/4" cell fabrics. 9/16" headrail option available at no charge.

Day/Night Shade Features:

- Aluminum headrail and bottom rail
- Color of top rail will match top fabric, middle and bottom rail will match bottom fabric
- Light filtering product on top area, blackout fabric on bottom area
- Standard Cordless module
- Maximum size is 72" x 72" for both loop control and cordless shades

Skylight Shade Features:

- Color coordinated middle rail with white (001) headrail and bottom rail.
- Side rails are available in the color cotton white (001) only
- Not available in 1 1/4" or Cell-in-a-Cell Fabrics
- Skylight shade can only be mounted inside
- Finished size must be provided, no deductions will be taken by manufacturer
- Headrail including endcaps will be 5/8" less than finished size
- Skylight poles are available in two options, ordered separately
3ft – 5ft \$75 retail
5ft – 9ft \$100 retail
- Automate Motorization available

Additional Shade Style Surcharges

- | | |
|---|---|
| • Top Down Bottom Up (Cordless or Clutch) | Retail
\$78 per shade |
| • Skylight | \$87 per shade |
| • Day/Night Shade – Two colors with top and bottom | Price as two shades & add together |
| • Tile Cutout – (No warranty with cutouts) | \$61 per side |
| • 2-on-1 or 3-on-1 Headrail (120" Maximum width) | Price as individual shades & add together |
| • 3/4" Modern headrail with 9/16" or 7/16" cell fabric choice | \$24 per shade |

Light Blockers (only available in White)

- Top Light Blocker (one piece per shade cut to the shade width with no deduction) \$8 per ft
- Side Light Blockers (2 pieces per shade cut the shade height with no deduction) \$10 per ft

System Upgrade Surcharges

Width to:	24	30	36	42	48	54	60	66	72	84	96	108	120	132	144
Non-Moveable Arch, Quarter Arch or									10%						
Moveable Trapezoid or Octagon									50%						
Slider – Left Stack and Right Stack									100%						
Slider Center Split									120%						

Size Limitations All Fabrics except Cell-in-a-Cell

	Cordless	Clutch	Clutch TDBU	Clutch Day/Night	TDBU Cordless	Day/Night	Day/Night Cordless	Skylight
Minimum Width	12"	12"	23"	23"	19"	12"	19"	16"
Minimum Length	10"	10"	10"	10"	10"	10"	10"	10"
Maximum Width	96"	120"	120"	72"	96"	72"	72"	60"
Maximum Height	84"	120"	120"	72"	84"	72"	72"	60"

Size Limitations Cell-in-a-Cell Fabric Only

	Cordless	Clutch	Clutch TDBU	Clutch Day/Night	TDBU Cordless	Day/Night	Day/Night Cordless	Skylight
Minimum Width	12"	12"	23"	23"	19"	12"	19"	n/a
Maximum Width	95"	120"	120"	72"	83"	72"	72"	n/a
Maximum Height	83"	100"	100"	72"	83"	72"	72"	n/a
Maximum Sq. ft.	45	83	83	36	47	36	36	n/a

9/16", 7/16", 1 1/4" Fabric Selections and color Components Coordination

9/16" Single Cell		
Solid Light Filtering		
Number	Description	Rail Color
PS310-001	Cotton	001
PS310-002	Snow White	002
PS310-003	Onion	006
PS310-004	Alabaster	006
PS310-005	Cream	006
PS310-006	Fawn	006
PS310-007	Biscuit	008
PS310-008	Pongee	008
PS310-009	Ocher	010
PS310-010	Tan	010
PS310-011	Terra Cotta	326
PS310-012	Cocoa	012
PS310-013	Spring Green	002
PS310-014	Water Green	015
PS310-015	Avocado	015
PS310-016	Roseate	016
PS310-019	Agate Red	020
PS310-020	Bordeaux	020
PS310-021	Gray Sheen	091
PS310-022	Marine Blue	091
PS310-023	Royal Gray	023
PS310-024	Jean Blue	023
PS310-025	Black	025
PS310-026	Wisteria	091
PS310-030	Anthracite	025
PS310-069	White Dove	001
PS310-070	Winter White	002
PS310-326	Dark Chocolate	326
PS310-346	Antique Pewter	025
PS310-470	Slate	025

9/16" Single Cell		
Linen Print Light Filtering		
Number	Description	Rail Color
PS331-012	Cocoa	012
PS331-032	Sand	006
PS331-034	Gray	091
PS331-326	Dark Chocolate	326
PS331-514	Misty Gray	002

9/16" Single Cell		
Slub Woven Light Filtering		
Number	Description	Rail Color
PS375-001	Cotton	001
PS375-004	Alabaster	006
PS375-012	Cocoa	012
PS375-012	Gray Sheen	091
PS375-326	Dark Chocolate	326

9/16" Single Cell		
Flame Retardant Light Filtering		
Number	Description	Rail Color
PS310-001FR	Cotton	001
PS310-006FR	Fawn	006
PS310-008FR	Pongee	008
PS310-070FR	Winter White	002

9/16" Single Cell		
Flame Retardant Blackout		
Number	Description	Rail Color
PS320-001FR	Cotton	001
PS320-006FR	Fawn	006
PS320-008FR	Pongee	008
PS320-070FR	Winter White	002

7/16" Double Cell		
Solid Light Filtering		
Number	Description	Rail Color
PX3A0-001	Cotton	001
PX3A0-002	Snow White	002
PX3A0-004	Alabaster	006
PX3A0-006	Fawn	006
PX3A0-008	Pongee	008
PX3A0-009	Ocher	010
PX3A0-010	Tan	010
PX3A0-020	Bordeaux	020
PX3A0-021	Gray Sheen	091
PX3A0-069	White Dove	001
PX3A0-070	Winter White	002
PX3A0-023	Royal Gray	023
PX3A0-025	Black	025
PX3A0-326	Dark Chocolate	326

1 1/4" Single Cell		
Light Filtering		
Number	Description	Rail Color
PS610-001	Cotton	001
PS610-006	Fawn	006
PS610-021	Gray Sheen	091

1 1/4" Single Cell		
Blackout		
Number	Description	Rail Color
PS620-001	Cotton	001
PS620-006	Fawn	006
PS620-021	Gray Sheen	091

9/16" Single Cell		
Solid Blackout		
Number	Description	Rail Color
PS320-001	Cotton	001
PS320-002	Snow White	002
PS320-003	Onion	006
PS320-004	Alabaster	006
PS320-006	Fawn	006
PS320-008	Pongee	008
PS320-009	Ocher	010
PS320-012	Cocoa	012
PS320-015	Avocado	015
PS320-020	Bordeaux	020
PS320-021	Gray Sheen	091
PS320-024	Jean Blue	023
PS320-025	Black	025
PS320-069	White Dove	001
PS320-070	Winter White	002
PS320-326	Dark Chocolate	326
PS320-346	Antique Pewter	025
PS320-470	Slate	025

3/4" Fabric Selections and color Components Coordination

3/4" Single Cell		
Solid Light Filtering		
Number	Description	Rail Color
PS410-001	Cotton	001
PS410-002	Snow White	002
PS410-003	Onion	006
PS410-004	Alabaster	006
PS410-005	Cream	006
PS410-006	Fawn	006
PS410-007	Biscuit	008
PS410-008	Pongee	008
PS410-009	Ocher	010
PS410-010	Tan	010
PS410-011	Terra Cotta	326
PS410-012	Cocoa	012
PS410-013	Spring Green	002
PS410-014	Water Green	015
PS410-015	Avocado	015
PS410-016	Roseate	016
PS410-019	Agate Red	020
PS410-020	Bordeaux	020
PS410-021	Gray Sheen	091
PS410-022	Marine Blue	091
PS410-023	Royal Gray	023
PS410-024	Jean Blue	023
PS410-025	Black	025
PS410-026	Wisteria	091
PS410-030	Anthracite	025
PS410-069	White Dove	001
PS410-070	Winter White	002
PS410-326	Dark Chocolate	025
PS410-346	Antique Pewter	025
PS410-470	Slate	025
PS410-519	Stone	012
PS410-786	Greige	002
PS410-788	Pale Slate	091

3/4" Single Cell		
Solid Blackout		
Number	Description	Rail Color
PS420-001	Cotton	001
PS420-002	Snow White	002
PS420-003	Onion	006
PS420-004	Alabaster	006
PS420-006	Fawn	006
PS420-008	Pongee	008
PS420-009	Ocher	010
PS420-012	Cocoa	012
PS420-015	Avocado	015
PS420-020	Bordeaux	020
PS420-021	Gray Sheen	091
PS420-024	Jean Blue	023
PS420-025	Black	025
PS420-030	Anthracite	025
PS420-069	White Dove	001
PS420-070	Winter White	002
PS420-326	Dark Chocolate	326
PS420-346	Antique Pewter	025
PS420-326	Dark Chocolate	326
PS420-470	Slate	025

3/4" Single Cell		
Smooth Light Filtering		
Number	Description	Rail Color
PS43C-001	Cotton	001
PS43C-002	Snow White	002
PS43C-005	Cream	006
PS43C-070	Winter White	006

3/4" Single Cell		
Smooth Blackout		
Number	Description	Rail Color
PS44C-002	Snow White	002
PS44C-005	Cream	006
PS44C-021	Gray Sheen	001
PS44C-070	Winter White	001

3/4" Single Cell		
Linen Print Light Filtering		
Number	Description	Rail Color
PS431-012	Cocoa	012
PS431-032	Sand	006
PS431-034	Gray	091
PS431-326	Dark Chocolate	326
PS431-514	Misty Gray	002

3/4" Single Cell		
Linen Print Black Out		
Number	Description	Rail Color
PS441-012	Cocoa	012
PS441-032	Sand	006
PS441-034	Gray	091
PS441-326	Dark Chocolate	326
PS441-514	Misty Gray	002

3/4" Single Cell		
Bamboo Print Light Filtering		
Number	Description	Rail Color
PS41RA-023	Royal Gray	091
PS41RA-346	Antique Pewter	091
PS41RA-514	Misty Gray	002
PS41RA-519	Stone	012
PS41RA-583	Dark Gray Sheen	091

3/4" Single Cell		
Bamboo Print Blackout		
Number	Description	Rail Color
PS42RA-023	Royal Gray	091
PS42RA-346	Antique Pewter	091
PS42RA-514	Misty Gray	002
PS42RA-519	Stone	012
PS42RA-583	Dark Gray Sheen	091

3/4" Single Cell		
Tweed Print Light Filtering		
Number	Description	Rail Color
PS413-069	White Dove	001
PS413-004	Alabaster	006
PS413-514	Misty Gray	002
PS413-583	Dark Gray Sheen	091
PS413-344	Pebble	025

3/4" Single Cell		
Tweed Print Blackout		
Number	Description	Rail Color
PS423-069	White Dove	001
PS423-004	Alabaster	006
PS423-514	Misty Gray	002
PS423-583	Dark Gray Sheen	091
PS423-344	Pebble	025

3/4" Cell-in-A-Cell		
Light Filtering		
Number	Description	Rail Color
PS41SS-001	Cotton	001
PS41SS-763	Taupe	002
PS41SS-764	Beige	002
PS41SS-765	Ivory	002
PS41SS-766	Classic Gray	091
PS41SS-823	Blue Wind	091
PS41SS-824	Gray Storm	091
PS41SS-025	Black	025
PS41SS-519	Bamboo Stone	012
PS41SS-346	Bamboo Antique	091

3/4" Cell-in-A-Cell		
Blackout		
Number	Description	Rail Color
PS42SS-001	Cotton	001
PS42SS-763	Taupe	002
PS42SS-764	Beige	002
PS42SS-765	Ivory	002
PS42SS-766	Classic Gray	091
PS42SS-823	Blue Wind	091
PS42SS-824	Gray Storm	091
PS42SS-025	Black	025
PS42SS-519	Bamboo Stone	012
PS42SS-346	Bamboo Antique	091

3/4" Single Cell		
Sheer Light Filtering		
Number	Color Description	Rail Color
PS360-001	Cotton	001
PS360-004	Alabaster	006

3/4" Single Cell		
LUX Linen Light Filtering		
Number	Description	Rail Color
PS47B-901	Porcelain	001
PS47B-919	Camel	006
PS47B-921	Stonington Gray	091
PS47B-930	Charcoal	091
PS47B-992	Hazelnut	012

3/4" Single Cell		
Slub Woven Light Filtering		
Number	Description	Rail Color
PS47S-001	Cotton	001
PS47S-004	Alabaster	006
PS47S-012	Cocoa	012
PS47S-021	Gray Sheen	091
PS47S-326	Dark Chocolate	326

3/4" Single Cell		
Whisper Woven Light Filtering		
Number	Description	Rail Color
PS47KO-001	Cotton	001
PS47KO-006	Fawn	006
PS47KO-583	Feather Gray	091
PS47KO-823	Blue Wind	091
PS47KO-824	Gray Storm	091

Color Availability

Cellular Fabrication Selection and Color Coordination																					
Fabric Color No.	Fabric Color Name	9/16"						3/4"										7/16"		1 1/4"	
		Single Cell LF	Single Cell BO	Single Cell Linen Print LF	Single Cell Slub Woven LF	Single Cell Fire Retardant LF & BO	Single Cell LF	Single Cell BO	Single Cell Bamboo LF & BO	Single Cell Smooth BO	Single Cell Linen Print LF & BO	Single Cell Tweed Print LF & BO	Single Cell Slub Woven LF	Single Cell LUX Linen LF	Single Cell Whisper Woven LF	Single Cell Sheer LF	Cell-In-A-Cell LF & BO	Double Cell LF	Single Cell LF	Single Cell BO	
001	Cotton	Yes	Yes	n/a	Yes	Yes	Yes	Yes	n/a	n/a	n/a	n/a	Yes	n/a	Yes	Yes	Yes	Yes	Yes	Yes	
002	Snow White	Yes	Yes	n/a	n/a	n/a	Yes	Yes	n/a	Yes	n/a	n/a	n/a	n/a	n/a	n/a	n/a	Yes	n/a	n/a	
003	Onion	Yes	Yes	n/a	n/a	n/a	Yes	Yes	n/a	n/a	n/a	n/a	n/a	n/a	n/a	n/a	n/a	n/a	n/a	n/a	
004	Alabaster	Yes	Yes	n/a	Yes	n/a	Yes	Yes	n/a	n/a	n/a	Yes	Yes	n/a	n/a	Yes	n/a	Yes	n/a	n/a	
005	Cream	Yes	n/a	n/a	n/a	n/a	Yes	n/a	n/a	Yes	n/a	n/a	n/a	n/a	n/a	n/a	n/a	Yes	n/a	n/a	
006	Fawn	Yes	Yes	n/a	n/a	Yes	Yes	Yes	n/a	n/a	n/a	n/a	n/a	n/a	Yes	n/a	n/a	Yes	Yes	Yes	
007	Biscuit	Yes	n/a	n/a	n/a	n/a	Yes	n/a	n/a	n/a	n/a	n/a	n/a	n/a	n/a	n/a	n/a	Yes	n/a	n/a	
008	Pongee	Yes	Yes	n/a	n/a	Yes	Yes	Yes	n/a	n/a	n/a	n/a	n/a	n/a	n/a	n/a	n/a	Yes	n/a	n/a	
009	Ocher	Yes	Yes	n/a	n/a	n/a	Yes	Yes	n/a	n/a	n/a	n/a	n/a	n/a	n/a	n/a	n/a	Yes	n/a	n/a	
010	Tan	Yes	n/a	n/a	n/a	n/a	Yes	n/a	n/a	n/a	n/a	n/a	n/a	n/a	n/a	n/a	n/a	Yes	n/a	n/a	
011	Terra Cotta	Yes	n/a	n/a	n/a	n/a	Yes	n/a	n/a	n/a	n/a	n/a	n/a	n/a	n/a	n/a	n/a	n/a	n/a	n/a	
012	Cocoa	Yes	Yes	Yes	Yes	n/a	Yes	Yes	n/a	n/a	Yes	n/a	Yes	n/a	n/a	n/a	n/a	Yes	n/a	n/a	
013	Spring Green	Yes	n/a	n/a	n/a	n/a	Yes	n/a	n/a	n/a	n/a	n/a	n/a	n/a	n/a	n/a	n/a	n/a	n/a	n/a	
014	Water Green	Yes	n/a	n/a	n/a	n/a	Yes	Yes	n/a	n/a	n/a	n/a	n/a	n/a	n/a	n/a	n/a	n/a	n/a	n/a	
015	Avocado	Yes	Yes	n/a	n/a	n/a	Yes	n/a	n/a	n/a	n/a	n/a	n/a	n/a	n/a	n/a	n/a	n/a	n/a	n/a	
016	Roseate	Yes	n/a	n/a	n/a	n/a	Yes	n/a	n/a	n/a	n/a	n/a	n/a	n/a	n/a	n/a	n/a	Yes	n/a	n/a	
019	Agate Red	Yes	n/a	n/a	n/a	n/a	Yes	n/a	n/a	n/a	n/a	n/a	n/a	n/a	n/a	n/a	n/a	n/a	n/a	n/a	
020	Bordeaux	Yes	Yes	n/a	n/a	n/a	Yes	Yes	n/a	n/a	n/a	n/a	n/a	n/a	n/a	n/a	n/a	Yes	n/a	n/a	
021	Gray Sheen	Yes	Yes	n/a	Yes	n/a	Yes	Yes	n/a	Yes	n/a	n/a	Yes	n/a	n/a	n/a	n/a	Yes	Yes	Yes	
022	Marine Blue	Yes	n/a	n/a	n/a	n/a	Yes	n/a	n/a	n/a	n/a	n/a	n/a	n/a	n/a	n/a	n/a	n/a	n/a	n/a	
023	Royal Gray	Yes	n/a	n/a	n/a	n/a	Yes	n/a	Yes	n/a	n/a	n/a	n/a	n/a	n/a	n/a	n/a	Yes	n/a	n/a	
024	Jean Blue	Yes	Yes	n/a	n/a	n/a	Yes	Yes	n/a	n/a	n/a	n/a	n/a	n/a	n/a	n/a	n/a	Yes	n/a	n/a	
025	Black	Yes	Yes	n/a	n/a	n/a	Yes	Yes	n/a	n/a	n/a	n/a	n/a	n/a	n/a	n/a	Yes	Yes	n/a	n/a	
026	Wisteria	Yes	n/a	n/a	n/a	n/a	Yes	n/a	n/a	n/a	n/a	n/a	n/a	n/a	n/a	n/a	n/a	n/a	n/a	n/a	
030	Anthracite	Yes	n/a	n/a	n/a	n/a	Yes	Yes	n/a	n/a	n/a	n/a	n/a	n/a	n/a	n/a	n/a	n/a	n/a	n/a	
032	Sand	n/a	n/a	Yes	n/a	n/a	n/a	n/a	n/a	n/a	Yes	n/a	n/a	n/a	n/a	n/a	n/a	n/a	n/a	n/a	
034	Gray	n/a	n/a	Yes	n/a	n/a	n/a	n/a	n/a	Yes	n/a	n/a	n/a	n/a	n/a	n/a	n/a	n/a	n/a	n/a	
069	White Dove	Yes	Yes	n/a	n/a	n/a	Yes	Yes	n/a	n/a	n/a	Yes	n/a	n/a	n/a	n/a	n/a	Yes	n/a	n/a	
070	Winter White	Yes	Yes	n/a	n/a	Yes	Yes	Yes	n/a	Yes	n/a	n/a	n/a	n/a	n/a	n/a	n/a	Yes	n/a	n/a	
326	Dark Chocolate	Yes	Yes	Yes	Yes	n/a	Yes	Yes	n/a	n/a	Yes	n/a	Yes	n/a	n/a	n/a	n/a	Yes	n/a	n/a	
344	Pebble	n/a	n/a	n/a	n/a	n/a	n/a	n/a	n/a	n/a	Yes	n/a	n/a	n/a	n/a	n/a	n/a	n/a	n/a	n/a	
346	Antique Pewter	n/a	n/a	n/a	n/a	n/a	Yes	Yes	Yes	n/a	n/a	n/a	n/a	n/a	n/a	Yes	n/a	n/a	n/a	n/a	
470	Slate	Yes	Yes	n/a	n/a	n/a	Yes	Yes	n/a	n/a	n/a	n/a	n/a	n/a	n/a	n/a	n/a	n/a	n/a	n/a	
514	Misty Gray	n/a	n/a	Yes	n/a	n/a	n/a	n/a	Yes	n/a	Yes	Yes	n/a	n/a	n/a	n/a	n/a	n/a	n/a	n/a	
519	Stone	n/a	n/a	n/a	n/a	n/a	Yes	n/a	Yes	n/a	n/a	n/a	n/a	n/a	n/a	Yes	n/a	n/a	n/a	n/a	
583	Dark Grey Sheen	n/a	n/a	n/a	n/a	n/a	n/a	n/a	Yes	n/a	n/a	Yes	n/a	n/a	Yes	n/a	n/a	n/a	n/a	n/a	
763	Taupe	n/a	n/a	n/a	n/a	n/a	n/a	n/a	n/a	n/a	n/a	n/a	n/a	n/a	n/a	Yes	n/a	n/a	n/a	n/a	
764	Beige	n/a	n/a	n/a	n/a	n/a	n/a	n/a	n/a	n/a	n/a	n/a	n/a	n/a	n/a	Yes	n/a	n/a	n/a	n/a	
765	Ivory	n/a	n/a	n/a	n/a	n/a	n/a	n/a	n/a	n/a	n/a	n/a	n/a	n/a	n/a	Yes	n/a	n/a	n/a	n/a	
766	Classic Gray	n/a	n/a	n/a	n/a	n/a	n/a	n/a	n/a	n/a	n/a	n/a	n/a	n/a	n/a	Yes	n/a	n/a	n/a	n/a	
786	Greige	n/a	n/a	n/a	n/a	n/a	Yes	n/a	n/a	n/a	n/a	n/a	n/a	n/a	n/a	n/a	n/a	n/a	n/a	n/a	
788	Pale Slate	n/a	n/a	n/a	n/a	n/a	Yes	n/a	n/a	n/a	n/a	n/a	n/a	n/a	n/a	n/a	n/a	n/a	n/a	n/a	
823	Blue Wind	n/a	n/a	n/a	n/a	n/a	n/a	n/a	n/a	n/a	n/a	n/a	n/a	Yes	n/a	Yes	n/a	Yes	n/a	n/a	
824	Gray Storm	n/a	n/a	n/a	n/a	n/a	n/a	n/a	n/a	n/a	n/a	n/a	n/a	Yes	n/a	Yes	n/a	n/a	n/a	n/a	
901	Porcelain	n/a	n/a	n/a	n/a	n/a	n/a	n/a	n/a	Yes	n/a	n/a	Yes	n/a	n/a	n/a	n/a	n/a	n/a	n/a	
919	Camel	n/a	n/a	n/a	n/a	n/a	n/a	n/a	n/a	Yes	n/a	n/a	Yes	n/a	n/a	n/a	n/a	n/a	n/a	n/a	
921	Stonington Gray	n/a	n/a	n/a	n/a	n/a	n/a	n/a	n/a	Yes	n/a	n/a	Yes	n/a	n/a	n/a	n/a	n/a	n/a	n/a	
930	Charcoal	n/a	n/a	n/a	n/a	n/a	n/a	n/a	n/a	Yes	n/a	n/a	Yes	n/a	n/a	n/a	n/a	n/a	n/a	n/a	
992	Hazelnut	n/a	n/a	n/a	n/a	n/a	n/a	n/a	n/a	Yes	n/a	n/a	Yes	n/a	n/a	n/a	n/a	n/a	n/a	n/a	

Price Groups by Fabric Styles

Price Group by Fabric Type				
Cell Size	Cell Type	Filter	Style	Price Group
7/16"	Double Cell	Light Filtering	Light Filtering	4
9/16"	Single Cell	Light Filtering	Linen Print	1
			Light Filtering	2
			Flame Retardant	5
		Blackout	Slub Woven	9
			Blackout	6
3/4"	Single Cell	Light Filtering	Flame Retardant	9
			Smooth	1
			Linen Print	2
			Light Filtering	3
			Bamboo Print	3
			Tweed Print	3
			Whisper Woven	8
			Sheer	8
		Slub Woven	9	
		Blackout	Lux Linen	9
			Smooth	5
			Linen Print	6
		Cell-in-a-Cell	Blackout	7
	Bamboo Print		7	
1 1/4"	Single Cell	Light Filtering	Tweed Print	7
		Blackout	Blackout	8
1 1/4"	Single Cell	Light Filtering	Blackout	10
		Blackout	Blackout	7

Fabric Type by Price Group				
Cell Size	Cell Type	Filter	Style	Price Group
9/16"	Single Cell	Light Filtering	Linen Print	1
3/4"	Single Cell	Light Filtering	Smooth	1
9/16"	Single Cell	Light Filtering	Light Filtering	2
3/4"	Single Cell	Light Filtering	Linen Print	2
3/4"	Single Cell	Light Filtering	Light Filtering	3
3/4"	Single Cell	Light Filtering	Bamboo Print	3
3/4"	Single Cell	Light Filtering	Tweed Print	3
1 1/4"	Single Cell	Light Filtering	Light Filtering	3
7/16"	Double Cell	Light Filtering	Light Filtering	4
9/16"	Single Cell	Light Filtering	Flame Retardant	5
3/4"	Single Cell	Blackout	Smooth	5
9/16"	Single Cell	Blackout	Blackout	6
3/4"	Single Cell	Blackout	Linen Print	6
3/4"	Single Cell	Blackout	Blackout	7
3/4"	Single Cell	Blackout	Bamboo Print	7
3/4"	Single Cell	Blackout	Tweed Print	7
1 1/4"	Single Cell	Blackout	Blackout	7
3/4"	Single Cell	Light Filtering	Whisper Woven	8
3/4"	Single Cell	Light Filtering	Sheer	8
3/4"	Cell-in-a-Cell	Light Filtering	Light Filtering	8
9/16"	Single Cell	Light Filtering	Slub Woven	9
9/16"	Single Cell	Blackout	Flame Retardant	9
3/4"	Single Cell	Light Filtering	Slub Woven	9
3/4"	Single Cell	Light Filtering	Lux Linen	9
3/4"	Cell-in-a-Cell	Blackout	Blackout	10

Shade Pricing

Group 1

- 9/16" Single Cell Light Filtering Linen Print
- 3/4" Single Cell Light Filtering Smooth

Width to:	24	30	36	42	48	54	60	66	72	84	96	108	120	132	144
Length to: 36	143	164	187	212	233	262	286	310	337	390	440	491	543	595	644
42	153	178	204	232	257	287	316	345	372	431	489	545	603	661	717
48	163	191	219	250	276	312	341	374	406	469	532	595	660	724	786
54	179	209	241	273	305	341	375	412	446	515	585	654	725	795	863
60	192	225	262	296	327	370	406	445	481	556	634	709	783	859	934
66	207	242	280	317	354	397	436	478	518	600	682	761	847	926	1008
72	220	257	299	340	379	425	469	513	555	641	732	817	906	993	1081
78	231	272	315	358	406	451	499	546	593	685	780	871	965	1059	1152
84	240	285	333	378	426	474	524	574	622	718	820	917	1020	1119	1218
90	252	300	349	398	448	502	552	605	660	762	867	972	1078	1181	1287
96	263	313	364	416	469	524	580	636	689	799	910	1018	1130	1240	1350
108	286	340	397	455	513	575	636	695	757	877	999	1118	1243	1362	1483
120	306	369	431	496	560	627	691	759	823	954	1087	1218	1353	1484	1617
132	326	395	463	533	604	676	748	818	889	1034	1177	1318	1464	1603	1746
144	349	422	497	572	648	726	802	879	956	1110	1264	1418	1576	1725	1880

Group 2

- 9/16" Single Cell Light Filtering
- 3/4" Single Cell Light Filtering Linen Print

Width to:	24	30	36	42	48	54	60	66	72	84	96	108	120	132	144
Length to: 36	161	185	212	240	266	298	325	352	382	442	501	556	618	677	732
42	174	202	231	265	292	326	360	390	423	490	554	619	685	751	814
48	185	217	249	284	314	354	388	425	461	533	604	677	751	823	893
54	202	237	273	310	346	388	426	469	506	586	664	743	825	902	980
60	219	255	297	336	373	420	461	505	548	634	718	805	890	976	1063
66	235	274	317	361	403	452	495	543	589	681	776	866	963	1052	1145
72	250	291	339	387	431	482	532	583	631	730	833	928	1031	1128	1228
78	263	310	358	407	461	513	567	621	674	779	885	990	1098	1205	1309
84	273	324	378	431	484	539	595	652	707	817	931	1043	1160	1271	1383
90	286	341	396	452	510	570	627	688	750	867	984	1104	1224	1343	1461
96	299	355	414	472	533	595	659	720	783	908	1034	1157	1286	1409	1535
108	325	387	452	516	584	653	721	791	859	996	1134	1269	1412	1547	1685
120	349	419	492	563	636	713	786	862	936	1085	1236	1385	1538	1687	1836
132	371	448	526	605	687	767	849	929	1011	1174	1337	1497	1663	1822	1985
144	396	480	565	650	737	826	912	999	1087	1262	1436	1611	1789	1960	2136

Group 3

- 3/4" Single Cell Light Filtering
- 1 1/4" Single Cell Light Filtering
- 3/4" Single Cell Light Filtering Bamboo Print
- 3/4" Single Cell Light Filtering Tweed Print

Width to:	24	30	36	42	48	54	60	66	72	84	96	108	120	132	144
Length to: 36	174	200	229	261	287	321	351	381	413	477	540	601	666	730	791
42	188	218	250	286	316	352	389	423	457	529	600	669	740	811	879
48	200	234	268	307	340	383	420	459	498	575	653	730	810	888	964
54	218	256	296	336	373	419	460	507	546	631	718	802	890	974	1058
60	236	275	320	362	402	454	498	546	592	683	777	870	962	1054	1147
66	253	297	344	390	435	488	534	587	636	735	838	935	1040	1136	1237
72	269	315	366	417	466	520	575	629	681	789	899	1003	1112	1217	1327
78	289	342	394	448	508	564	625	683	742	857	975	1090	1210	1327	1442
84	301	357	416	474	533	594	657	718	779	899	1027	1148	1277	1400	1525
90	315	376	437	498	560	628	691	758	826	955	1084	1215	1348	1479	1611
96	328	392	457	520	587	657	725	794	862	1000	1139	1275	1415	1552	1690
108	358	425	498	568	642	718	795	871	947	1097	1250	1398	1555	1704	1856
120	384	461	542	621	701	785	867	949	1031	1195	1362	1527	1694	1858	2023
132	408	494	580	667	757	844	935	1025	1114	1292	1473	1650	1833	2008	2187
144	436	528	622	717	812	910	1004	1100	1196	1391	1582	1775	1972	2159	2353

*Notes: 2-on-1 and 3-on-1 headrail option is strongly recommended for all blinds measuring 96" or more in width or height.
 * Any orders with a product over 90" width will have an additional oversized fee. See full shipping policy for details.

Shade Pricing

Group 4

· 7/16" Double Cell Light Filtering

Width to:	24	30	36	42	48	54	60	66	72	84	96	108	120	132	144
Length to: 36	189	216	249	280	334	343	376	410	442	509	577	640	708	771	835
42	207	238	272	313	342	386	421	461	496	570	647	720	798	869	943
48	215	253	291	334	368	410	452	493	537	616	700	781	864	944	1025
54	235	273	315	360	402	448	493	538	583	670	761	850	943	1026	1116
60	257	298	346	390	436	489	536	589	636	735	833	930	1029	1108	1222
66	276	323	373	423	474	531	584	637	691	800	905	1011	1120	1225	1332
72	293	340	395	449	505	564	619	677	736	847	964	1079	1190	1304	1413
78	313	370	429	489	551	612	674	737	800	923	1049	1171	1299	1421	1544
84	328	390	452	518	581	648	714	783	847	979	1111	1244	1380	1509	1640
90	345	410	478	546	615	687	757	830	901	1041	1182	1322	1465	1605	1745
96	360	431	499	573	647	720	797	872	946	1095	1248	1394	1545	1691	1839
108	392	466	545	626	708	791	870	955	1038	1201	1361	1526	1693	1852	2018
120	429	511	602	692	783	874	964	1057	1147	1327	1512	1693	1876	2056	2237
132	463	558	657	756	855	956	1058	1157	1258	1459	1661	1860	2063	2255	2457
144	490	595	701	806	914	1023	1129	1237	1350	1564	1775	1989	2209	2420	2634

Group 5

· 3/4" Single Cell Blackout Smooth

· 9/16" Single Cell Light Filtering Flame Retardant

Width to:	24	30	36	42	48	54	60	66	72	84	96	108	120	132	144
Length to: 36	204	233	266	298	327	364	398	433	469	539	613	683	756	824	894
42	223	254	290	328	363	407	442	481	521	603	683	761	844	923	1047
48	240	278	320	363	402	449	492	540	584	677	769	858	954	1044	1133
54	264	303	349	398	442	493	542	593	640	743	844	944	1047	1145	1247
60	289	325	376	431	477	533	583	642	697	806	917	1023	1136	1248	1354
66	306	349	403	460	513	574	629	690	749	867	988	1107	1227	1340	1461
72	326	376	437	499	557	624	683	752	814	944	1079	1208	1338	1466	1597
78	347	397	463	529	595	663	730	802	868	1007	1147	1286	1428	1564	1704
84	362	418	489	560	627	701	770	848	919	1069	1216	1362	1515	1662	1811
90	383	446	521	595	670	749	823	906	983	1143	1300	1461	1623	1783	1945
96	396	466	545	625	702	786	866	952	1035	1201	1372	1539	1711	1881	2051
108	431	507	596	686	774	867	953	1049	1140	1325	1514	1699	1890	2077	2266
120	463	552	648	746	846	943	1042	1146	1246	1448	1652	1861	2068	2275	2536
132	502	598	708	816	927	1034	1142	1253	1365	1587	1814	2037	2270	2566	2925
144	535	641	757	875	1028	1115	1231	1349	1470	1710	1954	2197	2492	2849	3254

Group 6

· 9/16" Single Cell Blackout

· 3/4" Single Cell Blackout Linen Print

Width to:	24	30	36	42	48	54	60	66	72	84	96	108	120	132	144
Length to: 36	221	254	289	323	356	396	432	471	510	586	666	743	822	895	972
42	243	275	315	357	395	442	480	522	566	655	744	828	919	1003	1139
48	262	303	349	395	437	489	534	587	636	734	836	933	1037	1133	1231
54	286	329	379	432	481	535	589	645	697	806	919	1026	1139	1245	1356
60	314	353	409	468	518	580	635	698	757	877	997	1112	1235	1356	1471
66	333	378	438	499	557	624	683	750	814	942	1073	1204	1333	1457	1588
72	355	408	476	542	606	677	744	817	885	1027	1171	1312	1455	1595	1735
78	377	431	504	575	647	720	794	871	943	1094	1248	1398	1552	1699	1852
84	393	454	532	609	680	762	838	923	999	1163	1323	1481	1647	1807	1969
90	416	484	566	647	727	814	894	984	1069	1243	1415	1588	1765	1937	2114
96	431	506	593	679	763	855	941	1035	1125	1305	1492	1673	1861	2045	2230
108	469	552	648	746	841	941	1036	1140	1240	1441	1645	1847	2054	2258	2463
120	504	599	706	810	911	1026	1131	1246	1354	1574	1796	2023	2247	2472	2757
132	546	650	768	887	1029	1123	1242	1363	1483	1725	1972	2215	2467	2791	3178
144	582	698	823	950	1118	1211	1338	1466	1598	1859	2123	2390	2709	3096	3538

*Notes: 2-on-1 and 3-on-1 headrail option is strongly recommended for all blinds measuring 96" or more in width or height.

* Any orders with a product over 90" width will have an additional oversized fee. See full shipping policy for details

Shade Pricing

Group 7

- 3/4" Single Cell Blackout
- 1 1/4" Single Cell Blackout
- 3/4" Single Cell Blackout Bamboo Print
- 3/4" Single Cell Blackout Tweed Print

Width to:	24	30	36	42	48	54	60	66	72	84	96	108	120	132	144
Length to: 36	244	279	317	356	392	436	476	518	560	644	733	817	905	985	1069
42	267	303	347	392	434	485	528	575	624	720	818	911	1010	1103	1252
48	287	333	383	434	481	539	589	645	698	807	920	1026	1140	1247	1355
54	314	363	417	476	529	589	647	710	766	888	1010	1128	1252	1370	1492
60	346	389	449	514	570	637	697	768	833	964	1096	1224	1359	1492	1620
66	366	416	482	550	614	685	751	826	895	1037	1180	1324	1467	1603	1747
72	390	449	524	596	666	745	818	899	973	1129	1289	1444	1600	1754	1908
78	414	475	554	633	712	794	872	959	1037	1205	1372	1538	1707	1868	2036
84	433	499	586	671	749	840	922	1014	1099	1278	1456	1628	1812	1989	2165
90	458	533	624	712	800	895	984	1083	1175	1368	1555	1746	1942	2131	2324
96	474	556	652	748	841	940	1035	1138	1237	1436	1641	1840	2047	2250	2453
108	515	606	713	820	926	1036	1139	1254	1364	1585	1810	2032	2260	2483	2709
120	554	659	776	891	1035	1128	1245	1371	1490	1732	1976	2225	2472	2720	3032
132	600	715	845	975	1131	1235	1367	1499	1632	1899	2168	2437	2714	3069	3497
144	639	767	905	1046	1229	1333	1473	1614	1758	2045	2336	2628	2979	3405	3891

Group 8

- 3/4" Single Cell Light Filtering Whisper Woven
- 3/4" Single Cell Light Filtering Sheer
- 3/4" Cell-in-a-Cell Light Filtering

Width to:	24	30	36	42	48	54	60	66	72	84	96	108	120	132	144
Length to: 36	270	310	354	403	445	498	543	589	639	741	838	932	1034	1131	1225
42	291	338	388	443	489	547	603	655	708	820	929	1036	1146	1257	1362
48	309	363	417	476	527	594	649	711	771	891	1012	1131	1256	1376	1495
54	339	396	459	519	578	648	712	785	847	979	1110	1243	1380	1509	1641
60	366	427	498	562	624	703	771	845	917	1059	1204	1348	1491	1635	1779
66	393	460	532	604	675	756	829	910	985	1140	1298	1449	1611	1761	1916
72	417	488	567	646	720	807	890	975	1056	1221	1393	1554	1724	1888	2056
78	439	518	599	681	771	857	950	1038	1128	1303	1482	1658	1837	2016	2192
84	458	542	634	720	811	902	997	1091	1182	1368	1561	1744	1942	2126	2317
90	479	570	665	758	852	954	1049	1151	1253	1450	1649	1848	2049	2247	2446
96	499	595	692	792	891	997	1102	1207	1310	1518	1731	1937	2152	2358	2568
108	543	646	756	865	976	1093	1208	1323	1440	1667	1900	2125	2363	2590	2820
120	583	700	822	943	1066	1193	1316	1443	1566	1816	2070	2318	2574	2824	3073
132	621	751	880	1013	1150	1286	1421	1556	1693	1965	2238	2507	2786	3377	3846
144	663	803	944	1087	1234	1382	1527	1672	1819	2112	2405	2697	3278	3746	4281

*Notes: 2-on-1 and 3-on-1 headrail option is strongly recommended for all blinds measuring 96" or more in width or height.
 * Any orders with a product over 90" width will have an additional oversized fee. See full shipping policy for details

Shade Pricing

Group 9

- 9/16" Single Cell Light Filtering Slub Woven
- 9/16" Single Cell Blackout Flame Retardant
- 3/4" Single Cell Light Filtering Slub Woven
- 3/4" Single Cell Light Filtering Lux Linen

Width to:	24	30	36	42	48	54	60	66	72	84	96	108	120	132	144
Length to: 36	297	341	390	442	489	546	596	646	701	813	919	1023	1134	1242	1344
42	320	370	426	487	537	600	661	718	776	899	1020	1136	1257	1379	1495
48	339	398	458	521	577	651	713	780	845	978	1110	1242	1379	1511	1640
54	373	435	504	570	636	712	782	860	929	1074	1218	1365	1515	1658	1801
60	401	469	546	616	683	771	845	928	1005	1163	1320	1479	1634	1794	1951
66	431	504	584	662	741	830	910	998	1082	1251	1424	1590	1768	1933	2104
72	458	535	623	710	791	887	978	1070	1159	1339	1529	1705	1892	2071	2257
78	481	568	658	748	845	941	1043	1139	1238	1430	1625	1818	2016	2212	2404
84	502	595	694	791	890	990	1094	1198	1297	1500	1711	1913	2130	2333	2542
90	526	626	729	831	934	1046	1152	1263	1376	1590	1808	2028	2249	2466	2685
96	549	653	759	868	978	1094	1210	1324	1438	1667	1900	2124	2360	2587	2818
108	596	710	830	949	1072	1200	1325	1451	1579	1829	2083	2332	2593	2842	3096
120	638	768	902	1035	1169	1309	1444	1584	1717	1992	2271	2543	2825	3097	3372
132	681	824	965	1111	1262	1410	1561	1708	1857	2155	2457	2751	3057	3436	4002
144	727	881	1037	1194	1354	1516	1675	1834	1995	2318	2640	2959	3339	3889	4444

Group 10

- 3/4" Cell-in-a-Cell Blackout

Width to:	24	30	36	42	48	54	60	66	72	84	96	108	120	132	144
Length to: 36	342	391	447	510	562	628	686	744	806	934	1055	1177	1304	1428	1546
42	369	426	489	560	618	690	760	827	891	1035	1173	1306	1445	1587	1718
48	390	458	526	600	664	749	819	897	972	1125	1277	1428	1586	1738	1886
54	429	501	580	656	730	818	899	990	1069	1235	1402	1569	1743	1906	2071
60	461	539	627	709	786	887	972	1067	1157	1337	1518	1701	1880	2063	2244
66	496	580	671	761	852	954	1046	1147	1244	1439	1638	1828	2033	2223	2419
72	527	615	716	816	910	1020	1125	1230	1333	1540	1758	1961	2175	2382	2596
78	554	654	757	860	972	1082	1199	1310	1424	1644	1869	2090	2318	2545	2766
84	577	683	799	909	1023	1137	1259	1377	1492	1726	1969	2201	2450	2684	2923
90	604	719	839	956	1075	1204	1324	1453	1582	1829	2079	2331	2586	2836	3087
96	631	751	874	999	1125	1259	1390	1523	1653	1918	2185	2443	2715	2975	3242
108	686	816	954	1090	1233	1379	1524	1669	1816	2104	2397	2683	2981	3268	3559
120	734	884	1037	1190	1345	1505	1660	1822	1975	2291	2611	2925	3249	3562	3878
132	784	947	1110	1278	1451	1621	1794	1964	2135	2479	2825	3164	3515	3849	4192
144	837	1013	1192	1374	1557	1743	1926	2109	2294	2666	3035	3403	3781	4141	4513

*Notes: 2-on-1 and 3-on-1 headrail option is strongly recommended for all blinds measuring 96" or more in width or height.
 * Any orders with a product over 90" width will have an additional oversized fee. See full shipping policy for details

Simple Touch® Wand and Remote Motorization

Simple Touch® Wand

Simple Touch® Wand allows the convenience of motorized shade without needing to worry where the remote is. Operated by 8 AA batteries, this unique cordless, battery powered shade has a control on a wand handle. Simple Touch® Wand cellular shades are made with the heavy-duty headrail and finest cellular shade fabrics. We offer a variety of options for the consumers' convenience.

Features and Options:

- Components color coordinated to shade based on standard color coordination chart on page 5
- Minimum wand length 12", Maximum wand length 60"
- Standard location right side unless specified
- Limits will be preset at upper 0" and lower at the ordered drop. Consumers can set favorite position.
- Shades are installed with heavy duty brackets. Instructions and programming guide included in hardware bag
- Optional P-Box Hub for smart device control

Power options:

- Rechargeable battery pack included with motor surcharge.
- Power adapter – 70" including cord length in headrail, power extension cord optional

Simple Touch® Wand Motorization Surcharges	Retail
Simple Touch® Wand (added to base shade pricing)	\$371
Additional Rechargeable Battery Pack	\$137
Power adapter (with 70" cord)	\$59
Power extension cord (118")	\$29
Solar Panel	\$312
Simple Touch P-Box Hub	\$425



Simple Touch® Wand Size Limitation	Single Cell Light Filtering	Single Cell Blackout	Double Cell Blackout
Minimum Width	28"	28"	28"
Minimum Length	12"	12"	12"
Maximum Width	118"	118"	96"
Maximum Height	118"	118"	118"
Maximum Weight	9 lbs.	9 lbs.	9 lbs.

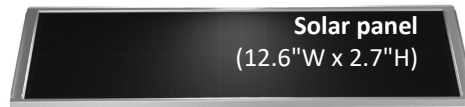

Simple Touch® Remote

Simple Touch® Remote Shades allow the convenience of remote-controlled motorized shades with an economical option to meet your budget. With a 15-channel remote, powered by a rechargeable battery pack.

Features and Options:

- Standard location right side unless specified
- Limits will be preset at upper 0" and lower at the ordered drop. Consumers can set favorite position.
- Shades are installed with heavy duty brackets. Instructions and programming guide included in hardware bag
- Optional P-Box Hub for smart device control

Power options:

- Rechargeable battery pack included with motor surcharge.
- Power adapter – 70" including cord length in headrail,
- Power extension cord optional

Simple Touch® Remote

- Standard Shade upper limit preset at 0" and bottom limit set at ordered drop.

Simple Touch® Remote Motorization Surcharges	Retail
Standard Motorized Shade (added to base shade pricing)	\$527
Additional Rechargeable Battery Pack	\$137
Controls	
Simple Touch® 15 Channel Remote	\$127
Additional Hardware	
Power adapter (with 70" cord)	\$59
Power extension cord (118")	\$29
Solar Panel	\$312
Simple Touch P-Box Hub	\$425

Simple Touch® Remote Motorization Size Limitation	Standard Shades	
	Single Cell	Double Cell
Minimum Width	28"	28"
Minimum Length	12"	12"
Maximum Width	120"	120"
Maximum Height	96 sq. ft	75 sq. ft.
Maximum Weight	15 lbs.	15 lbs.

Automate Motorization

Cellular Shade Collection shades powered by Rollease Acmeda Automate (RTS) Radio Technology System provides the convenience of remote-controlled motorized shades with a well know motorization brand. With two motor types, multiple remote options along with smart device and voice command capability adding Automate Motors to your shade allows a new level of shade control.



<u>Motorization Options</u>	<u>Retail</u>
Standard Shades	
• Li-ion Motorization with rechargeable battery pack & charger	\$654
Control Options	
5 Channel Push Remote	\$244
15 Channel Remote	\$283
5 Channel Wall Switch	\$205
15 Channel Wall Switch	\$244
Pulse 2 Hub	\$654
Additional Hardware	
Rechargeable Battery Pack	\$244
5v USB Wall Charger Block	\$29
5v USB Charge Cable 156"	\$49
96" motor extension cable	\$24
Solar Panel (only works with rechargeable battery pack)	\$312

<u>Size Limitations</u>	<u>Standard</u>	<u>TDBU</u>	<u>Skylight</u>
Minimum Width	18"	28"	24"
Minimum Height	12"	12"	10"
Maximum Width	120"	96"	60"
Maximum Height	120"	96"	60"



5 Channel Remote



15 Channel Remote



Li-ion Rechargeable Battery Features:

- Li-ion rechargeable battery pack and 80" charger included
- 1-1/2" color coordinated headrail
- Handheld remote control only (no hardwire)
- Radio frequency control
- Wall mount clips and headrail mounts are included
- Smart system capability with the Pulse 2 Hub
- Flash depth including the headrail and battery tube is 3 1/4"



Pulse 2 Hub



Solar Panel
12.6" W x 2.7" H

Sliders and Specialty Shapes

Slider Cellular Shade

Features:

- Available only in 9/16" & 3/4" light filtering and blackout cellular fabrics.
- Not available in 7/16", 3/4" Cell-in-a-Cell fabrics, Linen Prints or Sheer fabrics
- Aluminum headrail and side rails available in Vanilla 002 (off-white)
- Integrated headrail requires no valance
- Cordless design
- Finished shades available in Left Stack, Center Stack or Right Stack
- Ideal for patio doors, wide windows or room dividers
- Stationary rail bottom bracket can be mounted to the floor or side walls, extension brackets available upon request. To mount the stationary bottom rail bracket to the floor, the distance between the floor and the bottom of the shade cannot be larger than 1 1/2"

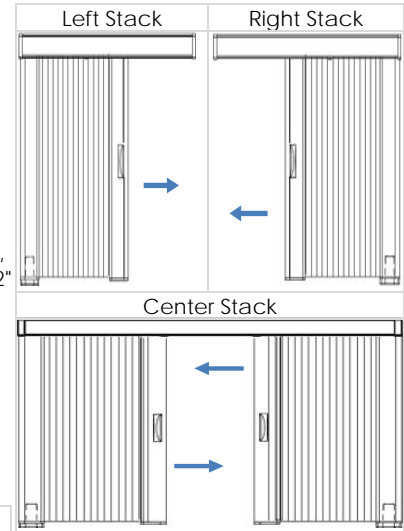

Deductions			Size Limitations		Stack Width			
	Width	Height	Minimum Width	24"		Left Stack	Right Stack	Center Stack
Inside Mount	1/4"	1/2"	Minimum Height	24"	Minimum Width	6"	6"	6" per side
Outside Mount	None	None	Maximum Width	120"				
			Maximum Height	118"				

Handle Position

Height ≤ 72"	At the center of the moving rail
Height 72 1/8" – 96"	38" from the bottom of the moving rail
Height 96 1/8" – 132"	48" from the bottom of the moving rail

Minimum Mounting Space

	Minimum Mounting Depth	Minimum Flush Mount Depth
Inside Mount	2 3/4"	4"
Outside Mount	2 1/4" (Minimum Flat Vertical Surface)	

Specialty Shades & Arches

- Specialty Shades and Arches are not available for skylights
- Finished size must be provided, manufacturer will not make any deductions
- Perfect versus Non-perfect arches or circles: Perfect arches are those where the radius of the circle are consistent on all points. Non-perfect arches are not consistent at all points. Deviation of 1/16" makes it imperfect. Templates will be required on all non-perfect arches or circles.

	Shape	Operational	Template	Width Minimum	Width Maximum	Length Minimum	Length Maximum
	Arch	Non-movable	Perfect – No Non-perfect – Yes	18"	84"	9"	48"
	Quarter Arch	Non-movable	Perfect – No Non-perfect – Yes	9"	50"		
	Circle	Non-movable	Perfect – No Non-perfect – Yes	9/16" – 9" 7/16" – 12"	9/16" – 42" 7/16" – 42"		
	Hexagon	Yes	Yes	12"	48"	12"	48"
	Octagon	Yes	Yes	12"	48"	12"	48"

Simply Cordless Systems

The Simply Cordless collection offers a cost effective solution for custom cordless cellular shades.

Features:

- Simply Cordless shades available in Standard, Top Down Bottom Up and Day/Night shades
- Standard and Top Down Bottom up available in both light filtering and blackout fabrics
- State of the Art vinyl headrail and bottom rail system
- 100% Polyester spun non-woven fabric
- Easy to install hidden brackets
- Day/Night shades fabric selection based on light filtering fabrics and will be the matching color in blackout fabric
- Cut to width only, no adjustments to length
 - Minimum Width
 - Standard 18"
 - Top Down Bottom Up 23"
 - Day/Night 23"
 - Lengths available: 48" or 72"

Trim Allowances	Standard	Top Down Bottom Up	Day/Night
30"	12" (6" per side)	7" (3.5" per side)	7" (3.5" per side)
38"	8" (4" per side)	8" (3" per side)	8" (3" per side)
54"	16" (8" per side)	16" (8" per side)	16" (8" per side)
72"	18" (9" per side)	18" (9" per side)	18" (9" per side)

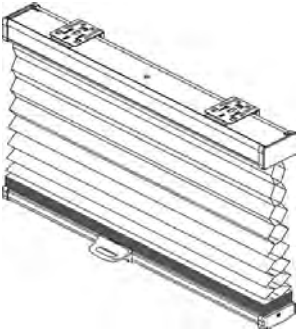
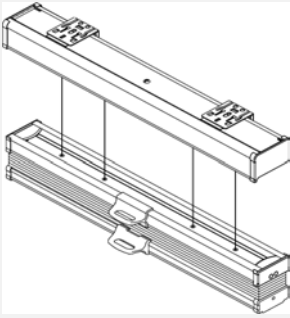
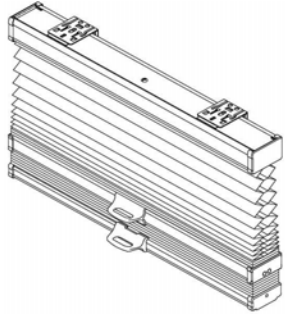
Simply Cordless Standard	Simply Cordless Top Down Bottom Up	Simply Cordless Day/Night																																																																																																																																																																																																																																																																																								
																																																																																																																																																																																																																																																																																										
<table border="1" style="width:100%; border-collapse: collapse;"> <thead> <tr> <th colspan="5">Light Filtering Pricing</th> </tr> <tr> <th>Width to:</th> <th>30"</th> <th>38"</th> <th>54"</th> <th>72"</th> </tr> </thead> <tbody> <tr> <td>Length to: 48"</td> <td>109</td> <td>132</td> <td>171</td> <td>233</td> </tr> <tr> <td>Length to: 72"</td> <td>124</td> <td>146</td> <td>189</td> <td>257</td> </tr> </tbody> </table> <table border="1" style="width:100%; border-collapse: collapse;"> <thead> <tr> <th colspan="5">Blackout Pricing</th> </tr> <tr> <th>Width to:</th> <th>30"</th> <th>38"</th> <th>54"</th> <th>72"</th> </tr> </thead> <tbody> <tr> <td>Length to: 48"</td> <td>159</td> <td>195</td> <td>258</td> <td>346</td> </tr> <tr> <td>Length to: 72"</td> <td>175</td> <td>220</td> <td>293</td> <td>396</td> </tr> </tbody> </table> <table border="1" style="width:100%; border-collapse: collapse;"> <thead> <tr> <th colspan="3">Simply Cordless Standard Color Chart</th> </tr> <tr> <th>Color No.</th> <th>Single Cell Pattern Color</th> <th>Type</th> </tr> </thead> <tbody> <tr><td>1G001</td><td>Cotton</td><td>Light Filtering</td></tr> <tr><td>1G006</td><td>Fawn</td><td>Light Filtering</td></tr> <tr><td>1G021</td><td>Gray Sheen</td><td>Light Filtering</td></tr> <tr><td>1G030</td><td>Anthracite</td><td>Light Filtering</td></tr> <tr><td>1G069</td><td>White dove</td><td>Light Filtering</td></tr> <tr><td>1G070</td><td>Winter White</td><td>Light Filtering</td></tr> <tr><td>1G346</td><td>Antique Pewter</td><td>Light Filtering</td></tr> <tr><td>1G492</td><td>Warm Cocoa</td><td>Light Filtering</td></tr> <tr><td>1G514</td><td>Misty Gray</td><td>Light Filtering</td></tr> <tr><td>1G519</td><td>Sticks & Stones</td><td>Light Filtering</td></tr> <tr><td>7G519</td><td>Bamboo Stone</td><td>Light Filtering</td></tr> <tr><td>7G344</td><td>Bamboo Pebble</td><td>Light Filtering</td></tr> <tr><td>2G001</td><td>Cotton</td><td>Blackout</td></tr> <tr><td>2G006</td><td>Fawn</td><td>Blackout</td></tr> <tr><td>2G021</td><td>Gray Sheen</td><td>Blackout</td></tr> <tr><td>2G030</td><td>Anthracite</td><td>Blackout</td></tr> <tr><td>2G069</td><td>White Dove</td><td>Blackout</td></tr> <tr><td>2G070</td><td>Winter White</td><td>Blackout</td></tr> <tr><td>2G346</td><td>Antique Pewter</td><td>Blackout</td></tr> <tr><td>2G492</td><td>Warm Cocoa</td><td>Blackout</td></tr> <tr><td>2G514</td><td>Misty Gray</td><td>Blackout</td></tr> <tr><td>2G519</td><td>Sticks & Stones</td><td>Blackout</td></tr> <tr><td>8G519</td><td>Bamboo Stone</td><td>Blackout</td></tr> <tr><td>8G344</td><td>Bamboo Pebble</td><td>Blackout</td></tr> </tbody> </table>	Light Filtering Pricing					Width to:	30"	38"	54"	72"	Length to: 48"	109	132	171	233	Length to: 72"	124	146	189	257	Blackout Pricing					Width to:	30"	38"	54"	72"	Length to: 48"	159	195	258	346	Length to: 72"	175	220	293	396	Simply Cordless Standard Color Chart			Color No.	Single Cell Pattern Color	Type	1G001	Cotton	Light Filtering	1G006	Fawn	Light Filtering	1G021	Gray Sheen	Light Filtering	1G030	Anthracite	Light Filtering	1G069	White dove	Light Filtering	1G070	Winter White	Light Filtering	1G346	Antique Pewter	Light Filtering	1G492	Warm Cocoa	Light Filtering	1G514	Misty Gray	Light Filtering	1G519	Sticks & Stones	Light Filtering	7G519	Bamboo Stone	Light Filtering	7G344	Bamboo Pebble	Light Filtering	2G001	Cotton	Blackout	2G006	Fawn	Blackout	2G021	Gray Sheen	Blackout	2G030	Anthracite	Blackout	2G069	White Dove	Blackout	2G070	Winter White	Blackout	2G346	Antique Pewter	Blackout	2G492	Warm Cocoa	Blackout	2G514	Misty Gray	Blackout	2G519	Sticks & Stones	Blackout	8G519	Bamboo Stone	Blackout	8G344	Bamboo Pebble	Blackout	<table border="1" style="width:100%; border-collapse: collapse;"> <thead> <tr> <th colspan="5">TDBU Light Filtering Pricing</th> </tr> <tr> <th>Width to:</th> <th>30"</th> <th>38"</th> <th>54"</th> <th>72"</th> </tr> </thead> <tbody> <tr> <td>Length to: 48"</td> <td>150</td> <td>173</td> <td>228</td> <td>318</td> </tr> <tr> <td>Length to: 72"</td> <td>166</td> <td>187</td> <td>251</td> <td>341</td> </tr> </tbody> </table> <table border="1" style="width:100%; border-collapse: collapse;"> <thead> <tr> <th colspan="5">TDBU Blackout Pricing</th> </tr> <tr> <th>Width to:</th> <th>30"</th> <th>38"</th> <th>54"</th> <th>72"</th> </tr> </thead> <tbody> <tr> <td>Length to: 48"</td> <td>201</td> <td>247</td> <td>315</td> <td>424</td> </tr> <tr> <td>Length to: 72"</td> <td>217</td> <td>279</td> <td>352</td> <td>477</td> </tr> </tbody> </table> <table border="1" style="width:100%; border-collapse: collapse;"> <thead> <tr> <th colspan="3">Simply Cordless Top Down Bottom Up Color Chart</th> </tr> <tr> <th>Color No.</th> <th>Single Cell Pattern Color</th> <th>Type</th> </tr> </thead> <tbody> <tr><td>1T001</td><td>Cotton</td><td>Light Filtering</td></tr> <tr><td>1T006</td><td>Fawn</td><td>Light Filtering</td></tr> <tr><td>1T021</td><td>Gray Sheen</td><td>Light Filtering</td></tr> <tr><td>1T030</td><td>Anthracite</td><td>Light Filtering</td></tr> <tr><td>1T069</td><td>White dove</td><td>Light Filtering</td></tr> <tr><td>1T070</td><td>Winter White</td><td>Light Filtering</td></tr> <tr><td>1T346</td><td>Antique Pewter</td><td>Light Filtering</td></tr> <tr><td>1T492</td><td>Warm Cocoa</td><td>Light Filtering</td></tr> <tr><td>1T514</td><td>Misty Gray</td><td>Light Filtering</td></tr> <tr><td>1T519</td><td>Sticks & Stones</td><td>Light Filtering</td></tr> <tr><td>7G519</td><td>Bamboo Stone</td><td>Light Filtering</td></tr> <tr><td>7G344</td><td>Bamboo Pebble</td><td>Light Filtering</td></tr> <tr><td>2T001</td><td>Cotton</td><td>Blackout</td></tr> <tr><td>2T006</td><td>Fawn</td><td>Blackout</td></tr> <tr><td>2T021</td><td>Gray Sheen</td><td>Blackout</td></tr> <tr><td>2T030</td><td>Anthracite</td><td>Blackout</td></tr> <tr><td>2T069</td><td>White Dove</td><td>Blackout</td></tr> <tr><td>2T070</td><td>Winter White</td><td>Blackout</td></tr> <tr><td>2T346</td><td>Antique Pewter</td><td>Blackout</td></tr> <tr><td>2T492</td><td>Warm Cocoa</td><td>Blackout</td></tr> <tr><td>2T514</td><td>Misty Gray</td><td>Blackout</td></tr> <tr><td>2T519</td><td>Sticks & Stones</td><td>Blackout</td></tr> <tr><td>8G519</td><td>Bamboo Stone</td><td>Blackout</td></tr> <tr><td>8G344</td><td>Bamboo Pebble</td><td>Blackout</td></tr> </tbody> </table>	TDBU Light Filtering Pricing					Width to:	30"	38"	54"	72"	Length to: 48"	150	173	228	318	Length to: 72"	166	187	251	341	TDBU Blackout Pricing					Width to:	30"	38"	54"	72"	Length to: 48"	201	247	315	424	Length to: 72"	217	279	352	477	Simply Cordless Top Down Bottom Up Color Chart			Color No.	Single Cell Pattern Color	Type	1T001	Cotton	Light Filtering	1T006	Fawn	Light Filtering	1T021	Gray Sheen	Light Filtering	1T030	Anthracite	Light Filtering	1T069	White dove	Light Filtering	1T070	Winter White	Light Filtering	1T346	Antique Pewter	Light Filtering	1T492	Warm Cocoa	Light Filtering	1T514	Misty Gray	Light Filtering	1T519	Sticks & Stones	Light Filtering	7G519	Bamboo Stone	Light Filtering	7G344	Bamboo Pebble	Light Filtering	2T001	Cotton	Blackout	2T006	Fawn	Blackout	2T021	Gray Sheen	Blackout	2T030	Anthracite	Blackout	2T069	White Dove	Blackout	2T070	Winter White	Blackout	2T346	Antique Pewter	Blackout	2T492	Warm Cocoa	Blackout	2T514	Misty Gray	Blackout	2T519	Sticks & Stones	Blackout	8G519	Bamboo Stone	Blackout	8G344	Bamboo Pebble	Blackout	<table border="1" style="width:100%; border-collapse: collapse;"> <thead> <tr> <th colspan="5">Day/Night Light Filtering Pricing</th> </tr> <tr> <th>Width to:</th> <th>30"</th> <th>38"</th> <th>54"</th> <th>72"</th> </tr> </thead> <tbody> <tr> <td>Length to: 48"</td> <td>228</td> <td>285</td> <td>374</td> <td>516</td> </tr> <tr> <td>Length to: 72"</td> <td>268</td> <td>333</td> <td>447</td> <td>597</td> </tr> </tbody> </table> <table border="1" style="width:100%; border-collapse: collapse;"> <thead> <tr> <th colspan="2">Simply Cordless Day/Night Color Chart</th> </tr> <tr> <th>Color No.</th> <th>Single Cell Pattern Color</th> </tr> </thead> <tbody> <tr><td>1D001</td><td>Cotton</td></tr> <tr><td>1D006</td><td>Fawn</td></tr> <tr><td>1D021</td><td>Gray Sheen</td></tr> <tr><td>1D030</td><td>Anthracite</td></tr> <tr><td>1D069</td><td>White dove</td></tr> <tr><td>1D070</td><td>Winter White</td></tr> <tr><td>1D346</td><td>Antique Pewter</td></tr> <tr><td>1D492</td><td>Warm Cocoa</td></tr> <tr><td>1D514</td><td>Misty Gray</td></tr> <tr><td>1D519</td><td>Sticks & Stones</td></tr> </tbody> </table>	Day/Night Light Filtering Pricing					Width to:	30"	38"	54"	72"	Length to: 48"	228	285	374	516	Length to: 72"	268	333	447	597	Simply Cordless Day/Night Color Chart		Color No.	Single Cell Pattern Color	1D001	Cotton	1D006	Fawn	1D021	Gray Sheen	1D030	Anthracite	1D069	White dove	1D070	Winter White	1D346	Antique Pewter	1D492	Warm Cocoa	1D514	Misty Gray	1D519	Sticks & Stones
Light Filtering Pricing																																																																																																																																																																																																																																																																																										
Width to:	30"	38"	54"	72"																																																																																																																																																																																																																																																																																						
Length to: 48"	109	132	171	233																																																																																																																																																																																																																																																																																						
Length to: 72"	124	146	189	257																																																																																																																																																																																																																																																																																						
Blackout Pricing																																																																																																																																																																																																																																																																																										
Width to:	30"	38"	54"	72"																																																																																																																																																																																																																																																																																						
Length to: 48"	159	195	258	346																																																																																																																																																																																																																																																																																						
Length to: 72"	175	220	293	396																																																																																																																																																																																																																																																																																						
Simply Cordless Standard Color Chart																																																																																																																																																																																																																																																																																										
Color No.	Single Cell Pattern Color	Type																																																																																																																																																																																																																																																																																								
1G001	Cotton	Light Filtering																																																																																																																																																																																																																																																																																								
1G006	Fawn	Light Filtering																																																																																																																																																																																																																																																																																								
1G021	Gray Sheen	Light Filtering																																																																																																																																																																																																																																																																																								
1G030	Anthracite	Light Filtering																																																																																																																																																																																																																																																																																								
1G069	White dove	Light Filtering																																																																																																																																																																																																																																																																																								
1G070	Winter White	Light Filtering																																																																																																																																																																																																																																																																																								
1G346	Antique Pewter	Light Filtering																																																																																																																																																																																																																																																																																								
1G492	Warm Cocoa	Light Filtering																																																																																																																																																																																																																																																																																								
1G514	Misty Gray	Light Filtering																																																																																																																																																																																																																																																																																								
1G519	Sticks & Stones	Light Filtering																																																																																																																																																																																																																																																																																								
7G519	Bamboo Stone	Light Filtering																																																																																																																																																																																																																																																																																								
7G344	Bamboo Pebble	Light Filtering																																																																																																																																																																																																																																																																																								
2G001	Cotton	Blackout																																																																																																																																																																																																																																																																																								
2G006	Fawn	Blackout																																																																																																																																																																																																																																																																																								
2G021	Gray Sheen	Blackout																																																																																																																																																																																																																																																																																								
2G030	Anthracite	Blackout																																																																																																																																																																																																																																																																																								
2G069	White Dove	Blackout																																																																																																																																																																																																																																																																																								
2G070	Winter White	Blackout																																																																																																																																																																																																																																																																																								
2G346	Antique Pewter	Blackout																																																																																																																																																																																																																																																																																								
2G492	Warm Cocoa	Blackout																																																																																																																																																																																																																																																																																								
2G514	Misty Gray	Blackout																																																																																																																																																																																																																																																																																								
2G519	Sticks & Stones	Blackout																																																																																																																																																																																																																																																																																								
8G519	Bamboo Stone	Blackout																																																																																																																																																																																																																																																																																								
8G344	Bamboo Pebble	Blackout																																																																																																																																																																																																																																																																																								
TDBU Light Filtering Pricing																																																																																																																																																																																																																																																																																										
Width to:	30"	38"	54"	72"																																																																																																																																																																																																																																																																																						
Length to: 48"	150	173	228	318																																																																																																																																																																																																																																																																																						
Length to: 72"	166	187	251	341																																																																																																																																																																																																																																																																																						
TDBU Blackout Pricing																																																																																																																																																																																																																																																																																										
Width to:	30"	38"	54"	72"																																																																																																																																																																																																																																																																																						
Length to: 48"	201	247	315	424																																																																																																																																																																																																																																																																																						
Length to: 72"	217	279	352	477																																																																																																																																																																																																																																																																																						
Simply Cordless Top Down Bottom Up Color Chart																																																																																																																																																																																																																																																																																										
Color No.	Single Cell Pattern Color	Type																																																																																																																																																																																																																																																																																								
1T001	Cotton	Light Filtering																																																																																																																																																																																																																																																																																								
1T006	Fawn	Light Filtering																																																																																																																																																																																																																																																																																								
1T021	Gray Sheen	Light Filtering																																																																																																																																																																																																																																																																																								
1T030	Anthracite	Light Filtering																																																																																																																																																																																																																																																																																								
1T069	White dove	Light Filtering																																																																																																																																																																																																																																																																																								
1T070	Winter White	Light Filtering																																																																																																																																																																																																																																																																																								
1T346	Antique Pewter	Light Filtering																																																																																																																																																																																																																																																																																								
1T492	Warm Cocoa	Light Filtering																																																																																																																																																																																																																																																																																								
1T514	Misty Gray	Light Filtering																																																																																																																																																																																																																																																																																								
1T519	Sticks & Stones	Light Filtering																																																																																																																																																																																																																																																																																								
7G519	Bamboo Stone	Light Filtering																																																																																																																																																																																																																																																																																								
7G344	Bamboo Pebble	Light Filtering																																																																																																																																																																																																																																																																																								
2T001	Cotton	Blackout																																																																																																																																																																																																																																																																																								
2T006	Fawn	Blackout																																																																																																																																																																																																																																																																																								
2T021	Gray Sheen	Blackout																																																																																																																																																																																																																																																																																								
2T030	Anthracite	Blackout																																																																																																																																																																																																																																																																																								
2T069	White Dove	Blackout																																																																																																																																																																																																																																																																																								
2T070	Winter White	Blackout																																																																																																																																																																																																																																																																																								
2T346	Antique Pewter	Blackout																																																																																																																																																																																																																																																																																								
2T492	Warm Cocoa	Blackout																																																																																																																																																																																																																																																																																								
2T514	Misty Gray	Blackout																																																																																																																																																																																																																																																																																								
2T519	Sticks & Stones	Blackout																																																																																																																																																																																																																																																																																								
8G519	Bamboo Stone	Blackout																																																																																																																																																																																																																																																																																								
8G344	Bamboo Pebble	Blackout																																																																																																																																																																																																																																																																																								
Day/Night Light Filtering Pricing																																																																																																																																																																																																																																																																																										
Width to:	30"	38"	54"	72"																																																																																																																																																																																																																																																																																						
Length to: 48"	228	285	374	516																																																																																																																																																																																																																																																																																						
Length to: 72"	268	333	447	597																																																																																																																																																																																																																																																																																						
Simply Cordless Day/Night Color Chart																																																																																																																																																																																																																																																																																										
Color No.	Single Cell Pattern Color																																																																																																																																																																																																																																																																																									
1D001	Cotton																																																																																																																																																																																																																																																																																									
1D006	Fawn																																																																																																																																																																																																																																																																																									
1D021	Gray Sheen																																																																																																																																																																																																																																																																																									
1D030	Anthracite																																																																																																																																																																																																																																																																																									
1D069	White dove																																																																																																																																																																																																																																																																																									
1D070	Winter White																																																																																																																																																																																																																																																																																									
1D346	Antique Pewter																																																																																																																																																																																																																																																																																									
1D492	Warm Cocoa																																																																																																																																																																																																																																																																																									
1D514	Misty Gray																																																																																																																																																																																																																																																																																									
1D519	Sticks & Stones																																																																																																																																																																																																																																																																																									

Warranty

CACO, Inc. will extend a limited lifetime warranty on Cellular Shade Collection shades, a limited 3 year warranty on fabric, cord and cord locks and a limited 3 year warranty on battery motors and wands. Each shade is warranted to be free from defects in materials and workmanship to the original owner, provided that the shades were properly installed in a window, door or other interior area for which they intended, maintained and cleaned with the manufacturer recommendations.

Damage resulting from misuse, abuse, exposure to the elements, including but not limited to exposure to salty air, discoloration due to sunlight or passage of time, exposure to humidity, accidents, improper installation, alterations or normal wear and tear upon the shades are not covered by this warranty. Some fading or reduction in color intensity may occur and should not be deemed defective. Returns for the above-mentioned reasons are not warranted.

The obligation of CACO's manufactured products and its distributors is limited to repair or replacement of the blinds or components found to be defective, at our option, provided the blinds are returned to an authorized CACO dealer or distributor and accompanied by "proof of purchase". CACO is not responsible for any labor costs associated with fabricating alterations, measuring, or installation and to include shipping charges.

This warranty is exclusive and in lieu of all other obligations, liabilities, or warranties. In no event shall CACO be liable or responsible for incidental or consequential damages, or for any other direct or indirect damage, loss, cost, expense, or fee. Some states do not allow the exclusion or limitations of incidental or consequential damages, so this limitation may not apply to you. This warranty gives you specific rights, and you may also have other rights, which vary from state to state.

Dual Sheer Shades

Features and Options



Loki Bark – Open fabric bands*



Loki Bark – Closed fabric bands*

Dual Sheer Shades, also known as zebra shades, provide the versatility of fabric roller shades by allowing light and privacy control while maintaining a unique decorative appeal. Constructed with dual fabric panels with alternating fabric and sheer bands, these shades can be fully raised but when completely lowered the horizontal bands can be controlled to provide different levels of privacy.

Shade operation

- When in the open position fabric bands allow light into the room.
- Closing the bands provide privacy or reduce glare.
- Full raised shades allow for full light and view

Cassette Options

Dual shades are available in two different cassette styles and both options are included in the shade prices.

Rounded Cassette:

- Standard cassette option
- 3 1/8" Cassette

Square Metal Cassette:

- Optional Cassette
- 3" Square Metal Cassette

Bottom Bar Options

Standard

- Standard available in two sizes, Square and Cordless Standard
- For an additional charge the bottom rail can be wrapped to match the shade fabric.
- Available in two sizes: Small and Large. Large bottom rail required on some fabrics, see fabric tables on page 52 for details.

Pattern Matching

Fabric band matching available on shades ordered in the same fabric and length only. When ordering please note the shades will be side by side.

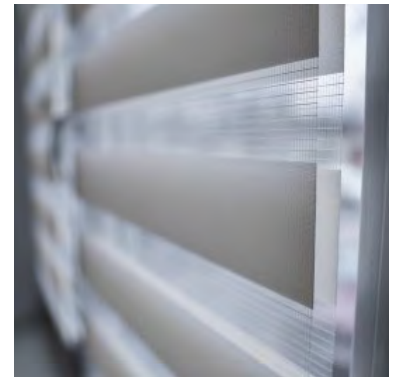

**Please note the Loki fabric featured is a room darkening pattern, various styles will result in different light filtering effects.*

Cassette Specifications

Cassette Options

- Dual Sheer Shades come standard with a rounded or square cassette.
- Rounded cassettes will include a fabric insert.
- Square cassettes come standard unwrapped or can be fabric wrapped for a surcharge.
- Available in 5 colors: white, beige, gray, bronze, and black.

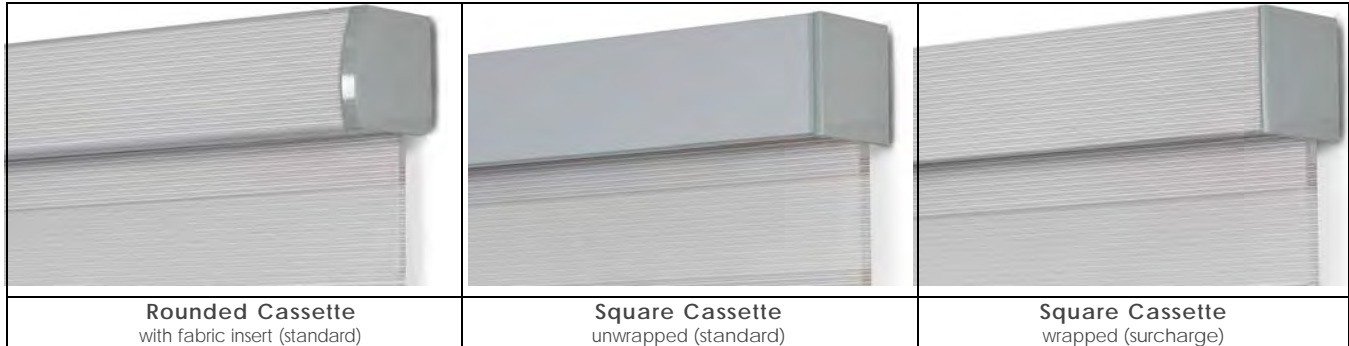

Cassette Color Options

- Cassette Cords and Bottom rail will be color coordinated.



Cassette Dimensions

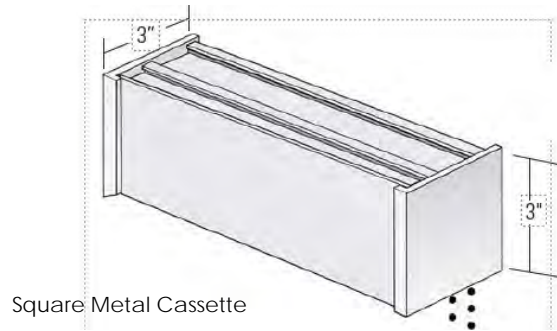
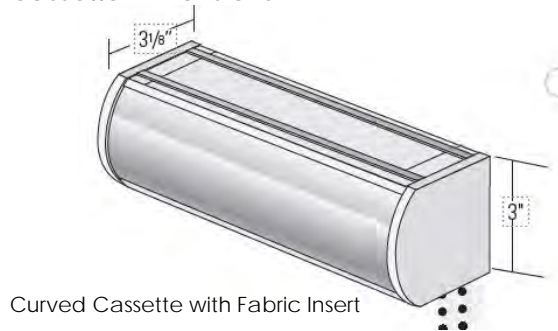

**Brackets
(Provided for both Curved & Square Cassettes)**

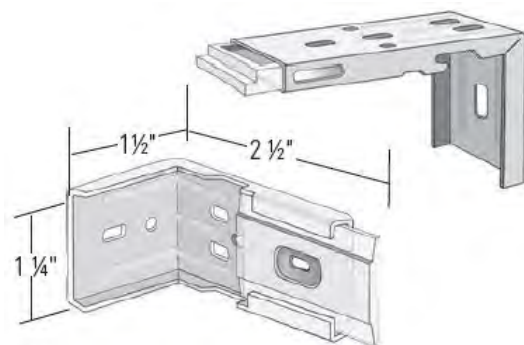

Cord Tensioner

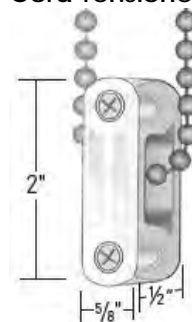

Bottom Bar Specifications

Bottom Bar Options

- Bottom bar color will match the cassette.
- Clutch and motorized shades come standard with an unwrapped rounded or square bottom bar, and can be fabric wrapped for a surcharge.
- Cordless bottom bars have a rounded shape and come standard unwrapped. Cordless bottom bars can be fabric wrapped for a surcharge.



Rounded Bottom Bar - Unwrapped
(standard for clutch & motorized)



Square Bottom Bar - Unwrapped
(standard for clutch & motorized)



Cordless Bottom Bar - Unwrapped
(standard for cordless)



Rounded Bottom Bar - Wrapped
(surcharge option for clutch & motorized)



Square Bottom Bar - Unwrapped
(surcharge option for clutch & motorized)

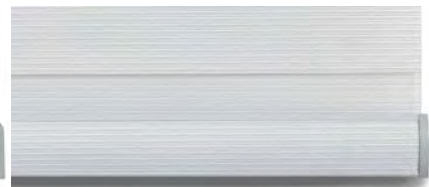

Cordless Bottom Bar - Wrapped
(surcharge option)

Dimensions

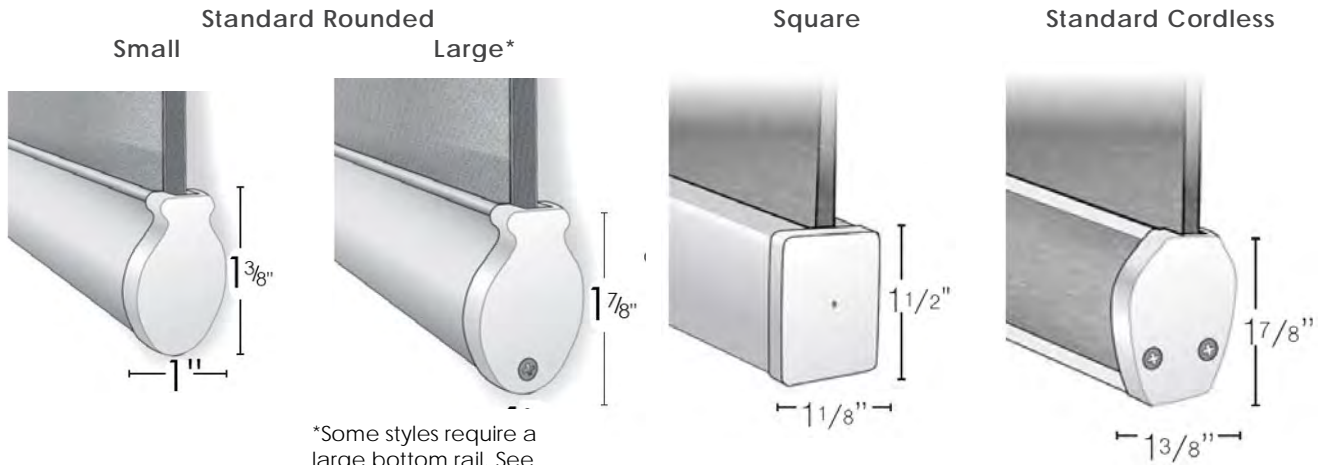

*Some styles require a large bottom rail. See page 59-60 for details

Dual Sheer Shades

Shade Specifications

SHADE INSTALLATION SPECIFICATIONS

	Width		Height		Inside Mount Depth			Control End Gap	Idle End Gap	Fabric Width Deduction
	Minimum Width*	Maximum Width*	Minimum Height*	Maximum Height*	Flush		Minimum			
					Top Mount	Face Mount	Top Mount			
<u>Curved Cassette</u>										
Clutch or Chain	16"	110"	20"	108"	3 3/4"	3 3/4"	1"	5/8"	3/8"	1"
Motorized Wand Control	23"	110"	20"	108"	3 3/4"	3 3/4"	1"	5/8"	3/8"	1"
Standard Lithium-Ion Motorized Remote Control	23"	110"	20"	108"	3 3/4"	3 3/4"	1"	5/8"	3/8"	1"
Quiet Lift Lithium-Ion Motorized Remote Control	29 1/2"	110"	20"	108"	3 3/4"	3 3/4"	1"	5/8"	3/8"	1"
DC Plugin* Motorized Remote Control	15"	110"	20"	108"	3 3/4"	3 3/4"	1"	5/8"	3/8"	1"
Cordless (< 60" long)	20"	96"	20"	99"	3 3/4"	3 3/4"	1"	5/8"	3/8"	1"
Cordless(60"+ long)	24"									
<u>Square Cassette</u>										
Clutch or Chain	16"	110"	20"	108"	3 5/8"	3 5/8"	1"	5/8"	3/8"	1"
Motorized Wand Control	23"	110"	20"	108"	3 5/8"	3 5/8"	1"	5/8"	3/8"	1"
Standard Motorized Remote Control	23"	110"	20"	108"	3 5/8"	3 5/8"	1"	5/8"	3/8"	1"
Quiet Lift Motorized Remote Control	29 1/2"	110"	20"	108"	3 5/8"	3 5/8"	1"	5/8"	3/8"	1"
DC Plugin* Motorized Remote Control	15"	110"	20"	108"	3 3/4"	3 3/4"	1"	5/8"	3/8"	1"
Cordless (< 60" long)	20"	96"	20"	99"	3 3/4"	3 3/4"	1"	5/8"	3/8"	1"
Cordless(60"+ long)	24"									

A deduction of 1/4" will be made to all IB shades.

Fabric Widths: Check the Fabric Reference Chart for individual fabric maximum width.

*Requires constant power supply for operation.

Fabric Reference

Color Code	Pattern Name	Color	Filter Type	Price Group	Fabric Width	Band Width		Component Color
						Fabric	Sheer	
AD13	Ada	Gray	Light Filtering	4	110"	3 in	2 in	Gray
AD12	Ada	Ivory	Light Filtering	4	110"	3 in	2 in	Ivory
AD11	Ada	White	Light Filtering	4	110"	3 in	2 in	White
N22	Asti	Anthracite	Light Filtering	1	110"	3 in	2 in	Grey
N20	Asti	Black/Black	Light Filtering	1	110"	3 in	2 in	Black
N17	Asti	Chocolate	Light Filtering	1	110"	3 in	2 in	Bronze
N13	Asti	Cream	Light Filtering	1	110"	3 in	2 in	Ivory
N24	Asti	Gray	Light Filtering	1	110"	3 in	2 in	Gray
N11	Asti	Ice White	Light Filtering	1	110"	3 in	2 in	White
N16	Asti	Latte	Light Filtering	1	110"	3 in	2 in	Bronze
N14	Asti	Oyster	Light Filtering	1	110"	3 in	2 in	Ivory
N15	Asti	Sand	Light Filtering	1	110"	3 in	2 in	Beige
N29	Asti	Stone	Light Filtering	1	110"	3 in	2 in	Grey
N21	Asti	Storm	Light Filtering	1	110"	3 in	2 in	Gray
N12	Asti	White	Light Filtering	1	110"	3 in	2 in	White
R218	Celeste	Antique	Light Filtering	4	110"	3 in	2 in	Brown
R214	Celeste	Bisque	Light Filtering	4	110"	3 in	2 in	Ivory
R112	Celeste	Black	Light Filtering	4	110"	3 in	2 in	Black
R216	Celeste	Earth	Light Filtering	4	110"	3 in	2 in	Brown
R111	Celeste	Off White	Light Filtering	4	110"	3 in	2 in	White
R219	Celeste	Silver Gray	Light Filtering	4	110"	3 in	2 in	Grey
R220	Celeste	Steel	Light Filtering	4	110"	3 in	2 in	Brown
R213	Celeste	White	Light Filtering	4	110"	3 in	2 in	White
R215	Celeste	White Gold	Light Filtering	4	110"	3 in	2 in	Ivory
CN04	Conway	Canyon	Light Filtering	1	110"	3 in	2 in	Bronze
CN03	Conway	Gray	Light Filtering	1	110"	3 in	2 in	Gray
CN02	Conway	Mineral	Light Filtering	1	110"	3 in	2 in	Gray
CN01	Conway	Sandstone	Light Filtering	1	110"	3 in	2 in	Ivory
CV12	Coventry	Alabaster	Light Filtering	4	110"	3.25 in	2.25 in	White
CV15	Coventry	Ash	Light Filtering	4	110"	3.25 in	2.25 in	White
CV17	Coventry	Espresso	Light Filtering	4	110"	3.25 in	2.25 in	White
CV14	Coventry	Soft Gray	Light Filtering	4	110"	3.25 in	2.25 in	White
CV16	Coventry	Titanium	Light Filtering	4	110"	3.25 in	2.25 in	White
CV11	Coventry	Winter	Light Filtering	4	110"	3.25 in	2.25 in	White
EM17	Emmerson	Ice	Light Filtering	4	108"	3.75 in	2.75 in	White
EM18	Emmerson	Ivory	Light Filtering	4	108"	3.75 in	2.75 in	Beige
EM16	Emmerson	Khaki	Light Filtering	4	108"	3.75 in	2.75 in	Bronze
EM12	Emmerson	Latte	Light Filtering	4	108"	3.75 in	2.75 in	Beige
EM11	Emmerson	Pearl	Light Filtering	4	108"	3.75 in	2.75 in	White
EM13	Emmerson	Soft Gray	Light Filtering	4	108"	3.75 in	2.75 in	Gray
FT04	Fletcher*	Almond	Room Darkening	5	108"	4 in	2.75 in	White
FT02	Fletcher*	Bark	Room Darkening	5	108"	4 in	2.75 in	Bronze
FT01	Fletcher*	Beige	Room Darkening	5	108"	4 in	2.75 in	Beige
FT03	Fletcher*	Gray	Room Darkening	5	108"	4 in	2.75 in	Gray
HD04	Hadley	Almond	Light Filtering	4	108"	4 in	2.75 in	White
HD02	Hadley	Bark	Light Filtering	4	108"	4 in	2.75 in	Bronze
HD01	Hadley	Beige	Light Filtering	4	108"	4 in	2.75 in	Beige
HD03	Hadley	Canvas	Light Filtering	4	108"	4 in	2.75 in	Beige
IV01	Irvine	Dark Gray	Light Filtering	4	108"	3 in	2 in	Gray
IV03	Irvine	Ice	Light Filtering	4	108"	3 in	2 in	White
IV02	Irvine	Soft Gray	Light Filtering	4	108"	3 in	2 in	Gray

* Pattern requires large bottom rail.

* Pattern not available with cordless system.

Fabric Reference

Color Code	Pattern Name	Color	Filter Type	Price Group	Fabric Width	Band Width		Component Color
						Fabric	Sheer	
LN15	Lennox*	Ash	Room Darkening	5	110"	3.25 in	2.25 in	Gray
LN13	Lennox*	Beige	Room Darkening	5	110"	3.25 in	2.25 in	Ivory
LN14	Lennox*	Chocolate	Room Darkening	5	110"	3.25 in	2.25 in	Brown
LN11	Lennox*	White	Room Darkening	5	110"	3.25 in	2.25 in	White
L60	Linen Sheer	Almond	Light Filtering	3	94"	3 in	2 in	Ivory
L63	Linen Sheer	Charcoal	Light Filtering	3	94"	3 in	2 in	Gray
L59	Linen Sheer	Ecru	Light Filtering	3	94"	3 in	2 in	Ivory
LK05	Loki*	Bark	Room Darkening	5	108"	4 in	2.75 in	Bronze
LK01	Loki*	Beige	Room Darkening	5	108"	4 in	2.75 in	Beige
LK02	Loki*	Charcoal	Room Darkening	5	108"	4 in	2.75 in	Gray
LK03	Loki*	Natural Gray	Room Darkening	5	108"	4 in	2.75 in	Gray
LK04	Loki*	White	Room Darkening	5	108"	4 in	2.75 in	Gray
M55	Lustre	Pearl	Light Filtering	4	94"	3 in	2 in	Ivory
M58	Lustre	Pewter	Light Filtering	4	94"	3 in	2 in	Gray
M56	Lustre	Silver	Light Filtering	4	94"	3 in	2 in	Gray
M57	Lustre	Steel	Light Filtering	4	94"	3 in	2 in	Gray
MR01	Marseille**	Driftwood	Light Filtering	4	106"	5.5 in	4 in	Gray
MR03	Marseille**	Ivory	Light Filtering	4	106"	5.5 in	4 in	Beige
MR02	Marseille**	Sky	Light Filtering	4	106"	5.5 in	4 in	Gray
MR04	Marseille**	Toffee	Light Filtering	4	106"	5.5 in	4 in	Bronze
D42	Milan	Anthracite	Light Filtering	3	110"	3 in	2 in	Black
D39	Milan	Ivory	Light Filtering	3	110"	3 in	2 in	Ivory
D41	Milan	Silver	Light Filtering	3	110"	3 in	2 in	Gray
D40	Milan	White Gold	Light Filtering	3	110"	3 in	2 in	Ivory
LB120	Nantucket*	Driftwood	Room Darkening	5	110"	3.25 in	2 in	Gray
LB121	Nantucket*	Gray	Room Darkening	5	110"	3.25 in	2 in	Gray
LB119	Nantucket*	Sand	Room Darkening	5	110"	3.25 in	2 in	Ivory
W31	Sierra	Champagne	Light Filtering	2	110"	3 in	2 in	Ivory
W35	Sierra	Chocolate	Light Filtering	2	110"	3 in	2 in	Brown
W34	Sierra	Clay	Light Filtering	2	110"	3 in	2 in	Beige
W33	Sierra	Earth	Light Filtering	2	110"	3 in	2 in	Ivory
W32	Sierra	Eggshell	Light Filtering	2	110"	3 in	2 in	Beige
W37	Sierra	Mineral	Light Filtering	2	110"	3 in	2 in	Gray
W36	Sierra	Steel Blue	Light Filtering	2	110"	3 in	2 in	Gray
GB2105	Umbria*	Chocolate	Room Darkening	5	110"	3.25 in	2 in	Brown
GB1101	Umbria*	Clay	Room Darkening	5	110"	3.25 in	2 in	Gray
GB2104	Umbria*	Latte	Room Darkening	5	110"	3.25 in	2 in	Ivory
GB1100	Umbria*	Ocher	Room Darkening	5	110"	3.25 in	2 in	Ivory
GB199	Umbria*	Platinum	Room Darkening	5	110"	3.25 in	2 in	Ivory
GB198	Umbria*	White	Room Darkening	5	110"	3.25 in	2 in	White
EB1110	Vicenza*	Black	Room Darkening	4	110"	3.25 in	2 in	Black
EB1109	Vicenza*	Charcoal	Room Darkening	4	110"	3.25 in	2 in	Black
EB2118	Vicenza*	Chocolate	Room Darkening	4	110"	3.25 in	2 in	Brown
EB2114	Vicenza*	Clay	Room Darkening	4	110"	3.25 in	2 in	Gray
EB2117	Vicenza*	Earth	Room Darkening	4	110"	3.25 in	2 in	Brown
EB2113	Vicenza*	Gray	Room Darkening	4	110"	3.25 in	2 in	Gray
EB1108	Vicenza*	Ivory	Room Darkening	4	110"	3.25 in	2 in	Ivory
EB2116	Vicenza*	Pewter	Room Darkening	4	110"	3.25 in	2 in	Gray
EB2111	Vicenza*	Silver	Room Darkening	4	110"	3.25 in	2 in	Ivory
EB2115	Vicenza*	Steel	Room Darkening	4	110"	3.25 in	2 in	Gray

* Pattern requires large bottom rail.

* Pattern not available with cordless system.

Control Options – Clutch and Wand Control

Clutch Control Shades

- Standard control is clutch with nylon cord loop. Cord loop is color coordinated to match the cassette color and is available in 5 colors: white, beige, gray, bronze and black.
- Clutches and loop tensioners are only available in clear.
- Cord loops come in standard sizes. The size closest to ¾ length of the shades is standard, however a different standard size can be selected at no additional charge.
- Metal chain is available with a surcharge option.

Standard Cord Lengths
19.5"
29.5"
39"
49"
59"
69"
79"
89"
98"



Cordless Control

- Easy to use cordless system
- Bottom rail will match the shade component color
- Fabric wrapped bottom rail not available

Pricing

Cordless System

Net

\$72

Wand Control

- Wand control shades are operated by re-chargeable lithium-ion battery motor.
- Motor easily charged using charging port in the back of the wand handle.
- Available in 5 colors: white, beige, gray and black.
- Available in 4 wand lengths: 24", 36", 48" and 60".

Pricing

Wand Control Motor
Wand Motor Charger

Net

\$100
\$27



Control Options – Remote Control

Motors

- Standard – Re-chargeable lithium ion battery
- Quiet Lift – Upgraded re-chargeable lithium ion battery that features a more quiet lift.
- Plug – requires nearby power outlet for continuous power
- Battery Pack – External re-chargeable lithium-ion battery pack.
- Battery Tube – External tube powered with AA batteries.
-

Operation

- Remotes are available in single or 15 channel remotes and each channel can operate up to 20 shades.
- Wall switches are available in single or 15 channel switches and each channel can operate up to 20 shades.
- Pro Hub provides automated control capabilities through smart phones or other devices.
 - Connects through 2.4 GHz Wi-Fi or directly to router with ethernet cable.
 - Works with Connector+ App, Amazon Alexa, Control4, Google Home, IFTTT, RTI, Samsung Smart Things, and Siri Short Cuts.



Single Channel Remote	15 Channel Remote	15 Channel Wall Switch	Connector Hub

Motorization Pricing	Net
Remote Control Motors	
Standard	\$172
Quiet Lift Motor	\$218
External Power Plug	\$172
External Battery Pack	\$172
External Battery Tube	\$172
Power	
Remote Charger (10 ft)	\$25
Remote Charger (16 ft)	\$31
Controls	
Single Channel Remote	\$27
15 Channel Remote	\$42
Single Channel Wall Switch	\$31
15 Channel Wall Switch	\$43
Pro Connector Hub	\$171

Motors

Motor Option	(Standard)	(Quiet Lift)	(Plug)	(Battery Pack)	(Battery Tube)
Motor Type	1.1 NM	1.1 NM	1.1 NM	1.1 NM	1.1 NM
Power Type	Internal Battery	Internal Battery	External Power	External Battery	External Battery
Power Supply	Rechargeable Lithium Ion Battery	Rechargeable Lithium Ion Battery	External Plug	Rechargeable Lithium-Ion Battery Pack	AA Battery Tube
Charger	•10' Micro USB •16' Micro USB	•10' Micro USB •16' Micro USB	N/A	•10' Micro USB •16' Micro USB	N/A
Available Controls	•Single Channel Remote •15 Channel Remote •Single Channel Wall Switch •15 Channel Wall Switch	•Single Channel Remote •15 Channel Remote •Single Channel Wall Switch •15 Channel Wall Switch	•15 Channel Remote •15 Channel Wall Switch	•15 Channel Remote •15 Channel Wall Switch	•15 Channel Remote •15 Channel Wall Switch
Automation	Pro Hub	Pro Hub	Pro Hub	Pro Hub	Pro Hub

Price Charts

Fabric Wrapped	24"	30"	36"	42"	48"	54"	60"	66"	72"	84"	96"	110"
Bottom Rail	29	37	46	52	60	67	83	83	89	105	119	135
Square Cassette	80	80	80	80	80	80	80	80	80	80	80	80

Group 1		Asti	Conway										
Width to:		24"	30"	36"	42"	48"	54"	60"	66"	72"	84"	96"	110"
Length to:	36"	213	228	243	261	277	292	318	340	358	419	479	539
	42"	223	242	261	279	298	336	373	397	419	489	558	629
	48"	234	255	277	298	340	383	425	453	479	558	639	719
	54"	243	267	292	336	383	431	479	511	539	629	719	808
	60"	255	282	318	373	425	479	532	567	600	698	798	899
	66"	266	294	352	409	469	527	584	624	658	769	879	987
	72"	277	318	383	448	511	576	640	680	719	838	958	1077
	78"	288	345	415	486	554	622	692	735	778	908	1037	1168
	84"	298	373	448	521	595	670	746	794	838	979	1118	1257
	90"	318	400	479	558	640	719	798	851	899	1047	1197	1348
	96"	340	425	511	595	680	766	852	907	958	1118	1276	1437
108"	383	479	576	670	766	861	958	1019	1077	1257	1437	1616	

Group 2		Sierra											
Width to:		24"	30"	36"	42"	48"	54"	60"	66"	72"	84"	96"	110"
Length to:	36"	259	274	289	306	322	338	368	391	414	483	553	621
	42"	267	288	306	324	343	387	430	458	483	565	644	725
	48"	279	301	322	343	392	442	491	522	553	644	735	828
	54"	289	313	338	387	442	496	553	589	621	725	828	931
	60"	301	328	368	430	491	553	614	652	691	805	919	1035
	66"	312	340	406	471	540	606	675	719	758	885	1012	1138
	72"	322	368	442	516	590	662	735	783	828	965	1104	1242
	78"	333	398	479	558	639	718	797	849	896	1046	1196	1345
	84"	343	430	516	601	685	772	859	914	965	1126	1286	1449
	90"	368	461	553	644	735	828	919	980	1035	1207	1378	1552
	96"	392	491	590	685	785	883	981	1044	1104	1286	1472	1655
108"	442	553	662	772	883	993	1104	1174	1242	1449	1655	1863	

Group 3		Linen Sheer	Milan										
Width to:		24"	30"	36"	42"	48"	54"	60"	66"	72"	84"	96"	110"
Length to:	36"	301	318	336	353	369	387	392	432	457	531	607	683
	42"	312	333	353	373	392	442	458	503	531	621	708	798
	48"	324	347	369	392	449	504	522	576	607	708	810	911
	54"	336	362	387	442	504	568	589	647	683	798	911	1024
	60"	347	375	420	491	562	630	653	720	759	885	1012	1139
	66"	358	390	463	540	617	693	720	791	836	974	1114	1252
	72"	369	420	504	589	673	757	785	862	911	1063	1214	1366
	78"	381	457	547	639	729	821	851	935	987	1151	1316	1481
	84"	392	491	589	687	785	883	916	1007	1063	1240	1418	1594
	90"	420	526	630	735	840	946	981	1078	1139	1330	1519	1708
	96"	449	562	673	785	896	1009	1046	1150	1214	1418	1620	1823
108"	504	630	757	883	1009	1135	1178	1296	1366	1594	1823	2050	

* Any orders with a product over 90" width will have an additional oversized fee. See full shipping policy for details.

Price Charts

Fabric Wrapped	24"	30"	36"	42"	48"	54"	60"	66"	72"	84"	96"	110"
Bottom Rail	29	37	46	52	60	67	83	83	89	105	119	135
Square Cassette	80	80	80	80	80	80	80	80	80	80	80	80

Group 4	Ada	Celeste	Coventry	Emerson	Hadley	Irvine	Lustre	Vicenza					
	Width to:	24"	30"	36"	42"	48"	54"	60"	66"	72"	84"	96"	110"
Length to:	36"	374	391	408	425	442	461	499	530	558	652	746	839
	42"	386	406	425	445	466	525	582	618	652	760	868	979
	48"	397	419	442	466	532	599	667	706	746	868	993	1117
	54"	408	434	461	525	599	673	748	795	839	979	1117	1257
	60"	419	448	499	582	667	748	832	883	931	1087	1242	1396
	66"	431	464	549	641	731	823	914	972	1024	1195	1366	1536
	72"	442	499	599	698	798	899	997	1060	1117	1304	1489	1676
	78"	453	542	650	757	865	972	1082	1148	1211	1412	1614	1815
	84"	466	582	698	815	931	1047	1163	1236	1304	1520	1738	1955
	90"	499	624	748	873	997	1122	1247	1324	1396	1630	1863	2095
	96"	532	667	798	931	1065	1197	1331	1412	1489	1738	1985	2234
108"	599	748	899	1047	1197	1347	1497	1590	1676	1955	2234	2515	

Group 5	Fletcher	Lennox	Loki	Nantucket	Umbria								
	Width to:	24"	30"	36"	42"	48"	54"	60"	66"	72"	84"	96"	110"
Length to:	36"	451	468	483	499	516	531	576	613	647	755	862	987
	42"	463	480	499	517	538	605	672	714	755	882	1007	1151
	48"	471	493	516	538	614	691	766	816	862	1007	1150	1319
	54"	483	508	531	605	691	777	862	918	970	1133	1294	1488
	60"	493	520	576	672	766	862	958	1020	1078	1258	1438	1647
	66"	504	534	632	738	844	950	1055	1122	1186	1384	1582	1812
	72"	516	576	691	805	921	1036	1150	1224	1294	1509	1726	1977
	78"	526	624	748	873	997	1122	1247	1326	1403	1636	1869	2140
	84"	538	672	805	940	1074	1208	1343	1428	1509	1762	2013	2306
	90"	576	719	862	1007	1150	1294	1438	1531	1619	1888	2157	2470
	96"	614	766	921	1074	1227	1381	1535	1633	1726	2013	2302	2635
108"	691	862	1036	1208	1381	1553	1726	1837	1942	2265	2590	2964	

* Any orders with a product over 90" width will have an additional oversized fee. See full shipping policy for details.

Warranty

Limited Lifetime Warranty

This product is warranted against defects in materials and workmanship, provided that:

1. The product was installed according to the product instructions.
2. Our recommendations were followed regarding limitations and specifications of the product.

CACO, Inc. reserves the right to determine if your shade warrants a repair or partial replacement of any parts. If necessary, CACO, Inc. will replace your shade with a new shade of equal or superior value. This shall be your sole remedy under this warranty.

Your shade may also show some fading and discoloration over time. This is not considered a defect for the purposes of this warranty.

This Limited Lifetime Warranty excludes all motors, controls and accessories that are warranted for only a period of five years from the date of purchase. Failure to follow the proper installation, charging and use instructions will invalidate the warranty for motors, remotes, wands and hubs.

This Limited Lifetime Warranty applies only to the original retail purchaser with proof of purchase.

This Limited Lifetime Warranty does not cover the removal or installation of original or replacement shades. This Limited Lifetime Warranty does not cover damage or defects caused by, or resulting from improper maintenance, neglect or improper use, wear and tear, abuse, neglect, accidents, alteration, commercial use, installation, removal or reinstallation or exposure to excessive moisture.

Your Rights Under State Law

These warranties give you specific legal rights. You may also have other rights which may vary from State to State. In no event shall CACO, Inc. be liable for incidental or consequential damages or for any other direct or indirect damage, loss, cost, expense or fee. Some states do not allow the exclusion or limitation of incidental or consequential damages, so the above limitation or exclusion may not apply to you. These warranties are exclusive and in lieu of all other obligations, liabilities, disclaimers or warranties.

SHEER SHADE FEATURES & BENEFITS

- Horizontal fabric vanes float between two layers of soft, knitted fabric sheers, to soften your view outside fabrics.
- All Sheer fabric vane colors are featured between two layers of sheer fabric.
- Available to widths of 116" and drops to 144" to provide visual elegance to the widest of windows.
- Vanes glide from open to closed to "out of sight" with elegant hardware.
- Four distinctly different variations of vane positions are available for numerous combinations of privacy, view and light control.
- An adjustable weight system in the bottom rail for on-the-spot skew adjustment for a balance appearance in the window.
- One headrail style to maintain your sophisticated look.
- Low side light gap provides minimal light leakage on shading sides and above the headrail for increased privacy.
- Easy to install hardware and brackets allows for effortless installations and easy removal for cleaning.
- May be ultrasonically or traditionally cleaned to stay bright and beautiful.
- Lifetime Limited Warranty as a commitment to your satisfaction.
- Sheer fabrics may be processed with a topical treatment to resist flames and to adhere to strict flammability codes. For more information, contact CACO, Inc.
- Available with multiple operating systems including standard loop control, cordless and several motorization options.

Fabric Collections:

Sheer Shades are available with three different fabric vane sizes, 2", 2 ½" and 3". Light filtering fabric gently filters light while room darkening casts deep room darkening shadows. Please note that room darkening is not a blackout fabric.

Viewing Options

Sheerview Horizontal shades provide a number of varied views to the outside for controlling light and privacy. Consequently, there are variations in visibility through the shades when the vanes are tilted to their maximum open positions. The following four modes can be obtained with standard shading operation when viewing the shading at eye level.

- Closed top, open bottom - By partially lowering the shade from the fully raised position, the upper portion of your window will become semi-opaque while allowing a clear view below.
- Fully private - When lowered completely, the shade provides complete privacy and softly diffuses light.
- Partially open - Opening the shade slightly will gradually increase the level of light and allow varying levels of "view-through."
- View-through when lowered - By completely opening the vanes, the shade provides a softened, veiled view to the outside.

Measuring

Inside Mount

Measure across the width of your window opening in three different places - top, middle and bottom. Measurements should be taken within the window jamb. Provide the smallest of the three measurements to your fabricator. Be exact. Your fabricator will make the necessary deductions to fit the window opening.

Measure the height of the window opening from the underside of the soffit to the surface of the windowsill in two places - use the smallest of these two measurements.

Outside Mount

Measure the exact width and height of the area to be covered. On the width, allow at least 1 ½" of an overlap on each side. An overlap of 3" on each side is recommended.

Be sure to take into consideration any obstructions such as window trim, molding, locks and window cranks. such as window trim, molding, locks and window cranks.

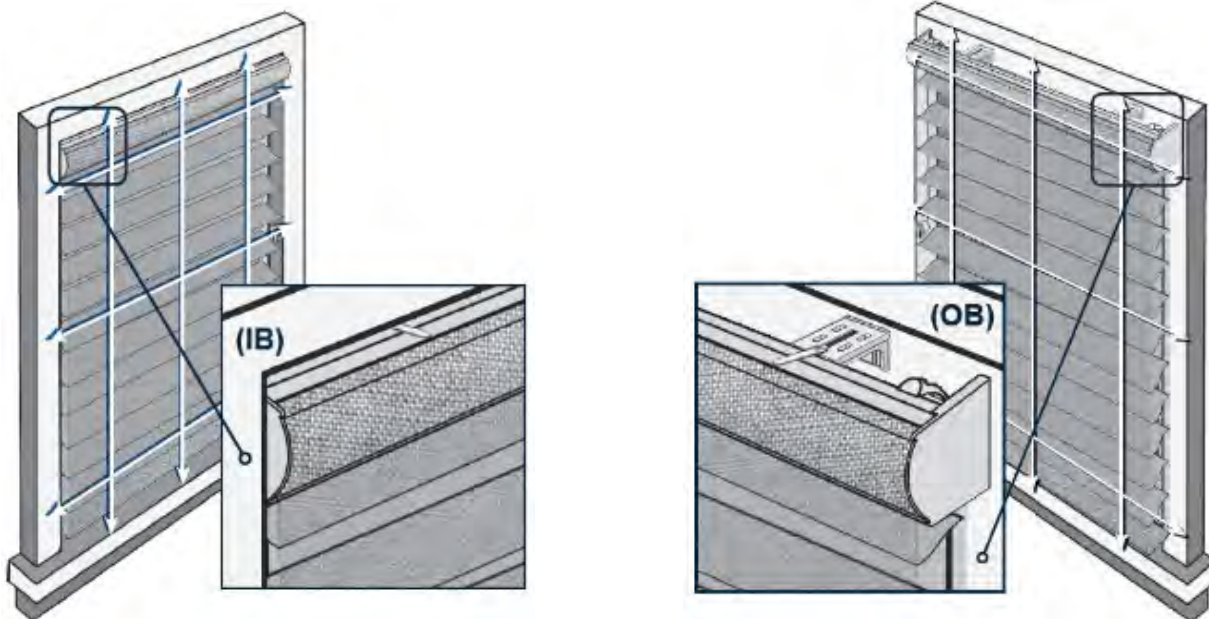

Design & Operation

Shade Operation

Sheer shades feature the Continuous Cord System or the Motorized System. Both Systems provide the ability to manipulate the shade into various viewing positions. From the closed and retracted position (fabric inside the headrail), lower the fabric by pulling down on the rear of the loop cord until you reach the desired shading position or press the down arrow of the remote control. Once lowered completely to the windowsill, continuing to pull the cord in the same direction, or pressing the down arrow on the remote control, will open the horizontal fabric vanes, offering varied views to the outside. To retract the shading, simply pull down on the front of the cord, or press the up arrow of the remote control, until the shade reaches the desired viewing mode or fabric position.



Headrail Information:

The Sheerview comes with a standard headrail wrapped in a color coordinated fabric with an option of color coordinated aluminum, unless otherwise specified. Headrail measurements include end caps and will measure ordered width minus: 1/8"

Side-by-Side Alignment:

When sheer shades are installed side-by-side, vane alignment can be guaranteed within 1/4" only if:

- The shades are the same color and ordered at the same time.
- The sum total of the widths of all shades needing alignment is less than 102".
- Side-by-side lineup must be specified when the order is placed.

Vane Closure

Sheer shade fabric vanes overlap and provide privacy when closed. However, the inherent nature of the fabric will cause a slight increase in the distance from the front sheer to back sheer as you move further down the shade. These vanes do not form a perfect seal against light leakage which is most visible toward the bottom of the shade.

Vane closure is measured as the distance between the front and rear fabric sheers 6" up from the lowest point of the bottom rail, with the shade fully lowered and the vanes closed. For sheer shades, the maximum distance from the front sheer to the back sheer when closed is 7/8". On room darkening fabrics, the distance is 5/8". Vane closure on all 3" fabrics will have a distance of 1"

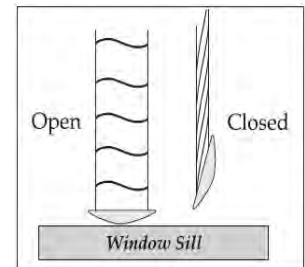

Finished Dimensions:

Once ordered and manufactured, the width of the fabric cannot be altered. The Manufacturer makes deductions to the width of window shadings depending on the type of mounting indicated. For all mounting types, the fabric will measure exactly the length ordered when the vanes are in the open or "view-through" position. When the vanes are rotated to the closed position, the shading will become 3/8" longer.

Height Considerations:

Your will be fabricated to the exact height ordered, when the vanes are in the closed position. When the vanes are rotated to the open position, the shade will become slightly longer.

When opened on an inside mount, the shading will be slightly longer than the ordered length. A slight puckering may occur when the vanes are in the open position. Rotating the vanes closed will cause the bottom rail to touch the windowsill before it begins to raise.

Length Considerations:

When closed on an inside mount, a slight furrow may occur on the lowermost sheer section because of contact with the sill. To compensate, slightly raise the shading until the rail begins to lift off the window sill. If preferred, the shading can be ordered 3/8" less than the measured height of the window opening. In this case, the bottom rail will be positioned 3/8" above the sill when the vanes are in the open position. Rotating the vanes closed will cause the bottom rail to touch the window sill and thus closing any unwanted space.

Fabric Considerations:

Due to variations in fabric weave and environmental conditions, the finished dimensions for both width and height may vary, plus or minus 1/8", from your order measurements. (1B) Fabric will measure ordered width minus: 15/16" (OB) Fabric will measure ordered width minus: 13/16"

Leveling Sheerview Horizontal Shades:

Sheer shades are leveled and weighted in the factory. When installed level, the fabric will not skew when raised. If the headrail is not installed level, skewing can occur that can damage the edge of the fabric. Be sure to follow the installation instructions carefully to ensure correct and balanced operation.



Note: Adjustable counter weight keeps sheer shade level.

Skew Adjusting Bottom Rail:

After installation, windows that are not square and level may cause the shadings to shift to one side as it rolls up, requiring adjustment of the bottom rail. To adjust the fabric, the weight in the bottom rail can be slid from one end to the other. If the fabric is skewing to the right, loosen the weight with a screwdriver and slide the weight to the right etc.

Fabric Selections

2" Woven Light Filtering

S50KN113	Winter White
S50KN125	Linen
S50KN206	Blossom
S50KN322	Beige
S50KN378	Java
S50KN823	Granite

2.5" Non-Woven Light Filtering

S65BN206	Blossom
S65BN311	Heather
S65BN312	Blush
S65BN322	Beige
S65BN627	Waterfall
S65BN823	Granite

3" Woven Light Filtering

S70KN113	Winter White
S70KN125	Linen
S70KN206	Blossom
S70KN322	Beige
S70KN378	Java
S70KN823	Granite

2" Non-Woven Light Filtering

S50PN100	Bright White
S50PN112	Alabaster
S50PN113	Winter White
S50PN206	Blossom
S60PN302	Sesame
S50PN322	Beige
S50PN378	Java
S50PN823	Granite

3" Non-Woven Light Filtering

S70PN100	Bright White
S70PN112	Alabaster
S70PN322	Beige
S70PN113	Winter White
S70PN206	Blossom
S70PN302	Sesame
S70PN823	Granite
S70PN378	Java
S70PN126	Luna
S70PN323	Romance
S70PN824	Rhinestone
S70PN821	Dusty Blue
S70PN503	Coastal Plain
S70PN507	Celadon
S70PN317	Plank

2" Non-Woven Room Darkening

S50PN100D	Bright White
S50PN125D	Linen
S50PN145D	Biscuit
S50PN322D	Beige
S50PN378D	Java
S50PN414D	Cornsilk
S50PN823D	Granite

3" Non-Woven Room Darkening

S70PN016D	Midnight
S70PN029D	Royal Blue
S70PN100D	Bright White
S70PN111D	Eggshell
S70PN114D	Greek Villa
S70PN125D	Linen
S70PN145D	Biscuit
S70PN303D	Khaki
S70PN312D	Barcelona Beige
S70PN321D	Natural Tan
S70PN322D	Beige
S70PN334D	Brick
S70PN378D	Java
S70PN414D	Cornsilk
S70PN823D	Granite
S70PN822D	Lazy Gray

System	Mount	Headrail Deduction	Fabric Deduction
Cordless	Inside	1/8"	1 1/8"
	Outside	None	3/4"
Clutch	Inside	1/8"	1"
	Outside	None	7/8"
Motorized	Inside	1/8"	1 1/8"
	Outside	None	7/8"

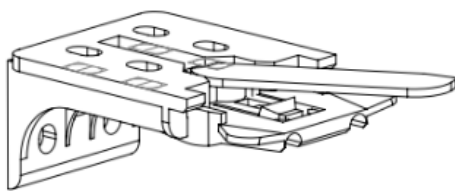

Standard Bracket

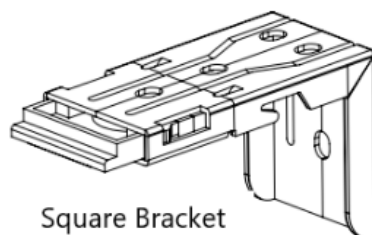

Square Bracket

Price Charts Woven - Light Filtering

Chart 1 2" Woven Light Filtering

Beige		Blossom		Granite		Java		Linen		Winter White				
Width to:	24"	30"	36"	42"	48"	54"	60"	66"	72"	84"	96"	108"	116"	
Length to:	36"	602	671	739	809	878	948	1015	1089	1260	1405	1546	1699	1955
	42"	630	705	778	858	931	1012	1089	1164	1339	1494	1650	1813	2085
	48"	667	739	824	904	989	1072	1163	1247	1427	1589	1760	1937	2227
	54"	690	777	865	958	1050	1140	1234	1334	1512	1685	1876	2064	2374
	60"	718	816	910	1007	1100	1203	1308	1412	1583	1790	1997	2197	2525
	66"	747	852	957	1057	1164	1274	1389	1498	1671	1899	2123	2335	2688
	72"	778	889	998	1108	1224	1344	1469	1583	1760	1999	2242	2466	2837
	78"	796	917	1035	1153	1275	1403	1530	1657	1839	2099	2349	2585	2972
	84"	830	957	1073	1209	1340	1473	1617	1745	1934	2210	2477	2722	3131
	90"	863	989	1120	1262	1401	1550	1687	1832	2023	2315	2600	2859	3289
	96"	891	1033	1169	1314	1469	1617	1768	1913	2117	2422	2720	2993	3441
	102"	1012	1164	1320	1483	1636	1781	1980	2175	2321	2628	2927	3220	3703
	108"	1064	1221	1383	1558	1714	1869	2079	2283	2436	2762	3081	3387	3897
	114"	1127	1295	1465	1650	1825	1988	2206	2422	2585	2927	3267	3593	4132
120"	1203	1381	1573	1762	1941	2123	2355	2585	2764	3132	3490	3840	4414	
132"	1383	1589	1807	2029	2233	2441	2708	2975	3176	3604	4014	4414	5078	
144"	1592	1825	2078	2331	2565	2809	3113	3420	3656	4142	4615	5078	5840	

Chart 2 3" Woven Light Filtering

Beige		Blossom		Granite		Java		Linen		Winter White				
Width to:	24"	30"	36"	42"	48"	54"	60"	66"	72"	84"	96"	108"	116"	
Length to:	36"	678	752	832	907	988	1068	1143	1225	1418	1579	1737	1912	2198
	42"	714	795	876	964	1048	1139	1225	1311	1508	1682	1854	2042	2347
	48"	751	833	928	1016	1113	1208	1308	1405	1605	1787	1978	2178	2502
	54"	774	874	972	1077	1178	1282	1388	1499	1699	1897	2113	225	2673
	60"	809	920	1023	1132	1235	1352	1471	1588	1782	2013	2247	2472	2843
	66"	839	958	1076	1192	1311	1433	1565	1685	1880	2136	2389	2628	3021
	72"	876	1000	1120	1245	1380	1514	1651	1782	1978	2252	2522	2774	3191
	78"	893	1034	1166	1295	1435	1579	1722	1866	2070	2364	2644	1441	3344
	84"	935	1076	1208	1360	1508	1656	1817	1966	2175	2489	2785	3063	3523
	90"	971	1113	1260	1420	1577	1744	1899	2061	2279	2607	2924	3216	3698
	96"	1003	1162	1315	1479	1651	1819	1991	2154	2381	2726	3061	3368	3872
	102"	1139	1313	1484	1668	1841	2003	2228	2444	2609	2957	3293	3623	4165
	108"	1196	1377	1557	1754	1929	2105	2340	2565	2741	3108	3463	3810	4382
	114"	1265	1457	1650	1854	2053	2235	2483	2722	2906	3293	3673	4041	4646
120"	1355	1551	1766	1985	2183	2389	2650	2906	3108	3523	3926	4319	4967	
132"	1557	1785	2031	2283	2513	2747	3048	3344	3573	4053	4515	4965	5711	
144"	1790	2053	2336	2623	2888	3161	3505	3846	4109	4659	5193	5710	6570	

* Any orders with a product over 90" width will have an additional oversized fee. See full shipping policy for details

Sheerview Horizontal Shade Collection

Price Charts Non-Woven - Light Filtering



Chart 3 2" Non-Woven Light Filtering

		Alabaster	Beige	Blossom	Bright White	Granite	Java	Winter White						
Width to:		24"	30"	36"	42"	48"	54"	60"	66"	72"	84"	96"	108"	116"
Length to:	36"	573	639	705	769	837	904	967	1037	1200	1339	1471	1618	1862
	42"	600	671	740	817	885	964	1037	1110	1275	1425	1571	1727	1986
	48"	635	705	785	861	942	1022	1108	1190	1358	1513	1676	1845	2121
	54"	655	739	823	910	1000	1086	1176	1269	1440	1605	1787	1967	2261
	60"	684	778	867	959	1048	1146	1245	1344	1508	1705	1903	2092	2405
	66"	710	811	909	1007	1110	1212	1324	1427	1592	1810	2022	2224	2559
	72"	740	847	950	1054	1167	1282	1400	1508	1676	1905	2136	2349	2702
	78"	758	874	986	1097	1213	1338	1456	1579	1754	1998	2237	2463	2831
	84"	791	909	1023	1152	1277	1403	1538	1663	1842	2105	2358	2591	2982
	90"	822	942	1066	1202	1334	1475	1607	1744	1928	2205	2476	2725	3132
	96"	849	984	1113	1252	1400	1538	1682	1823	2017	2308	2589	2850	3277
	102"	964	1110	1257	1412	1557	1697	1886	2072	2209	2503	2788	3069	3528
	108"	1013	1164	1318	1484	1632	1782	1981	2174	2321	2629	2933	3227	3711
	114"	1073	1233	1395	1571	1738	1894	2102	2308	2463	2788	3111	3423	3934
120"	1146	1315	1496	1679	1849	2022	2243	2463	2632	2983	3323	3657	4203	
132"	1318	1513	1722	1931	2125	2326	2580	2833	3026	3430	3822	4203	4835	
144"	1517	1738	1979	2221	2444	2679	2965	3256	3481	3946	4395	4835	5562	

Chart 4 2 1/2" Non-Woven Printed Light Filtering

		Beige	Blossom	Blush	Granite	Heather	Waterfall							
Width to:		24"	30"	36"	42"	48"	54"	60"	66"	72"	84"	96"	108"	116"
Length to:	36"	658	734	811	884	961	1038	1113	1194	1380	1537	1694	1848	2141
	42"	691	772	852	941	1020	1110	1194	1275	1468	1638	1807	1987	885
	48"	730	811	903	990	1084	1176	1274	1367	1562	1740	1929	2121	2439
	54"	754	849	947	1048	1150	1247	1352	1461	1655	1847	2056	2261	2601
	60"	785	896	998	1103	1205	1318	1432	1546	1735	1960	2187	2405	2766
	66"	817	953	1047	1157	1275	1394	1524	1641	1829	2081	2326	2559	2942
	72"	852	972	1093	1213	1342	1473	1609	1735	1929	2190	2457	2702	3107
	78"	870	1005	1133	1262	1395	1536	1675	1817	2016	2297	2575	2833	3256
	84"	908	1047	1177	1325	1469	1613	1769	1912	2117	2422	2712	2983	3429
	90"	945	1084	1226	1382	1534	1698	1848	2006	2228	2535	2847	3132	3602
	96"	977	1131	1281	1440	1609	1769	1937	2097	2318	2652	2980	3277	3767
	102"	1110	1275	1444	1623	1790	1950	2168	2381	2542	2878	3206	3529	4057
	108"	1166	1339	1517	1706	1876	2050	2280	2498	2668	3024	3374	3711	4266
	114"	1234	1419	1604	1807	1998	2178	2415	2652	2833	3206	3578	3935	4524
120"	1318	1513	1722	1931	2125	2326	2580	2833	3026	3430	3822	4203	4835	
132"	1517	1738	1979	2221	2444	2675	2965	3256	3481	3946	4395	4835	5562	
144"	1742	1999	2276	2554	2812	3075	3411	3745	4002	4538	5055	5560	6395	

Chart 5 3" Non-Woven Light Filtering

		Alabaster	Beige	Blossom	Bright White	Celadon	Coastal Plain	Dusty Blue	Luna					
Width to:		Luna	Granite	Java	Plank	Rhinestone	Romance	Winter White						
Width to:		24"	30"	36"	42"	48"	54"	60"	66"	72"	84"	96"	108"	116"
Length to:	36"	646	716	792	864	941	1016	1089	1167	1350	1505	1655	1822	2093
	42"	673	756	833	918	998	1085	1167	1247	1436	1602	1767	1944	2234
	48"	714	795	883	969	1059	1151	1245	1338	1530	1702	1885	2074	2384
	54"	738	832	927	1026	1121	1220	1322	1428	1618	1806	2012	2212	2546
	60"	769	877	973	1077	1177	1288	1402	1512	1697	1917	2140	2354	2707
	66"	798	910	1025	1134	1247	1365	1492	1605	1790	2034	2276	2503	2877
	72"	833	952	1068	1187	1314	1443	1573	1638	1885	2143	2402	2641	3038
	78"	852	985	1110	1233	1367	1505	1639	1776	1971	2249	2519	2770	3186
	84"	890	1025	1151	1296	1436	1577	1730	1872	2072	2370	2652	2918	3356
	90"	926	1059	1200	1352	1502	1662	1808	1964	2168	2482	2784	3062	3522
	96"	957	1106	12460	1408	1573	1731	1894	2052	2268	2596	2915	3207	3688
	102"	1085	1250	1413	1589	1754	1907	2122	2328	2484	2816	3136	3450	3967
	108"	1139	1311	1483	1668	1836	2006	2229	2444	2610	2959	3298	3630	4173
	114"	1206	1388	1571	1767	1955	2129	2365	2591	2769	3136	3499	3848	4426
120"	1289	1477	1681	1890	2079	2274	2523	2769	2959	3356	3739	4113	4730	
132"	1483	1699	1934	2174	2392	2616	2902	3186	3403	3860	4301	4729	5439	
144"	1705	1955	2224	2498	2751	3008	3338	3662	3913	4437	4946	5437	6257	

* Any orders with a product over 90" width will have an additional oversized fee. See full shipping policy for details

Price Charts Woven – Room Darkening

Chart 6 2" Non-Woven Room Darkening

		Beige	Biscuit	Bright White	Cornsilk	Granite	Java	Linen						
Width to:		24"	30"	36"	42"	48"	54"	60"	66"	72"	84"	96"	108"	116"
Length to:	36"	646	701	774	847	918	994	1064	1140	1320	1471	1618	1782	2049
	42"	659	738	815	898	973	1061	1140	1220	1403	1565	1727	1899	2184
	48"	698	774	864	947	1035	1124	1219	1307	1495	1664	1845	2029	2333
	54"	721	814	907	1002	1098	1195	1295	1397	1582	1766	1967	2164	2489
	60"	752	857	954	1053	1153	1260	1369	1479	1661	1875	2092	2302	2647
	66"	783	891	1001	1107	1220	1334	1457	1570	1750	1992	2223	2447	2814
	72"	815	931	1046	1159	1283	1410	1538	1658	1845	2096	2349	2584	2970
	78"	833	961	1085	1208	1334	1469	1601	1738	1928	2198	2463	2708	3114
	84"	869	1001	1126	1268	1406	1545	1693	1828	2024	2315	2595	2853	3281
	90"	904	1035	1174	1322	1468	1624	1768	1917	2121	2427	2725	2995	3443
	96"	935	1080	1222	1377	1538	1693	1851	2006	2218	2536	2850	3135	3606
	102"	1061	1220	1382	1552	1712	1866	2075	2279	2430	2754	3069	3374	3880
	108"	1114	1281	1449	1632	1796	1960	2179	2390	2554	2893	3227	3549	4082
	114"	1179	1357	1533	1727	1913	2082	2311	2536	2708	3069	3422	3764	4329
120"	1146	1446	1645	1848	2032	2223	2466	2708	2895	3281	3657	4022	3158	
132"	1449	1664	1893	2124	2338	2559	2837	3114	3329	3773	4203	4625	5318	
144"	1517	1913	2177	2442	2689	2940	3262	3582	2943	4340	4835	5318	6115	

Chart 7 3" Non-Woven Room Darkening -

		Beige Khaki	Brick Java	Biscuit Linen	Bright White Natural Tan	Cornsilk Royal Blue	Egg Shell	Granite	Greek Villa					
Width to:		24"	30"	36"	42"	48"	54"	60"	66"	72"	84"	96"	108"	116"
Length to:	36"	710	789	870	950	1034	1118	1197	1283	1484	1655	1822	2003	2303
	42"	742	832	916	1010	1097	1194	1283	1372	1579	1762	1944	2137	2459
	48"	785	874	970	1065	1166	1265	1370	1469	1682	1873	2074	2281	2622
	54"	812	915	1020	1128	1235	1343	1455	1573	1781	1985	2214	2434	2799
	60"	847	964	1073	1184	1296	1415	1541	1663	1866	2111	2354	2588	2977
	66"	878	1002	1127	1247	1372	1500	1639	1767	1968	2237	2503	2753	3165
	72"	916	1048	1176	1305	1445	1586	1729	1866	2074	2358	2641	2906	3342
	78"	936	1082	1220	1357	1502	1655	1803	1955	2167	2476	2770	3046	3504
	84"	979	1127	1265	1426	1579	1735	1904	2059	2279	2607	2918	3211	3691
	90"	1016	1166	1320	1489	1654	1826	1988	2160	2386	2729	3062	3368	3873
	96"	1051	1216	1377	1550	1729	1906	2084	2258	2496	2856	3207	3528	4057
	102"	1194	1374	1556	1748	1928	2099	2334	2561	2732	3096	3449	3794	4365
	108"	1252	1443	1631	1835	2021	2206	2452	2689	2872	3256	3628	3991	4591
	114"	1326	1526	1727	1944	2149	2344	2601	2853	3045	3449	3848	4235	4868
120"	1418	1625	1850	2078	2287	2503	2777	3045	3256	3691	4113	4526	5205	
132"	1631	1872	2127	2391	2632	2878	3193	3503	3742	4245	4729	5203	5984	
144"	1875	2150	2445	2749	3026	3311	3673	4029	4304	4881	5437	5984	6883	

* Any orders with a product over 90" width will have an additional oversized fee. See full shipping policy for details

Operating Systems, Options & Motorization Surcharges

Standard Features

- Fabric wrapped headrail
- Easy to install one clip brackets with shims to level shim
- Installed stoppers to prevent bottom rail from looping up into headrail when fully raised
- Bottom rail design reduces light gap when shade is in the fully lowered/closed position
- Adjustable counter weight helps to keep sheer shade level
- Braided polyester cord control loops
- Safety Cord loop tensioner
- Aluminum color coordinated headrail with fabric insert and color coordinated end caps

Shade Limitations				
	Minimum		Maximum	
	Width	Length	Width	Length
Cord Loop	7 1/2"	11"	116"	144"
Cordless	20"	11"	96"	96"
Motorized	24"	11"	96"	96"

No Charge Options

- Control position
- Extension Brackets – 4 1/2" L Brackets
- Spacer Blocks - 3/8"
- Hold down brackets
- Custom cord lengths up to 15'. Available in 12" increments only

Fabric Width Deductions			
	Idle End	Clutch End	Motor End
Cord Loop	3/8"	5/8"	n/a
Cordless	1/4"	1/4"	n/a
Motorized	3/8"	n/a	3/4"

Minimum Mounting Requirements	
Inside Mount	3 3/4"
Outside Mount	3/4"

Manual Operating System

- Standard Cord Loop
 - Cordless
- Standard Price Grids
\$65 Net

Standard Control Lengths	
Shade Height	Standard Loop
12" - 36"	24"
36" - 48"	36"
48" - 72"	48"
72" - 96"	60"
96" - 120"	72"

Motorization

Two available options: Wand Remote or Rechargeable Lithium Battery Motor

- Wand Remote including USB cable for charging \$100 Net
- Lithium Rechargeable battery motor installed \$200 Net
 - USB Charger \$20 Net
 - Single Channel Remote \$30 Net
 - 15 Channel Remote \$45 Net
 - Please Specify number of remotes, at least one remote control will be required.

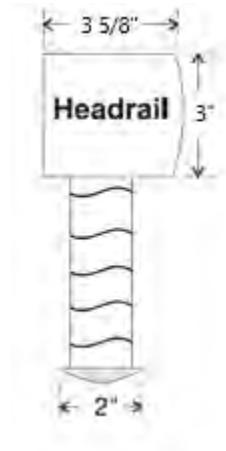
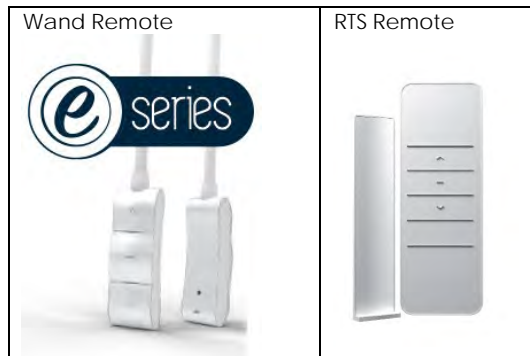

Child Safety, Care and Warranty

Child Safety

Our Sheer Shadings are designed with child safety as a priority. To reduce the risk of strangulation, our fabrication methods incorporate features to comply with the current ANSI cord safety standard. Fabrication methods include cord stops, Cord-Shield cording, and tension devices.

Caring for Shades

The soft, delicate feel of the fabric belies the durability of the material. It is made from a sturdy, knitted polyester fabric which can be feather dusted or vacuumed at a low setting. Spots or stains can be lightly rubbed clean with a damp sponge and mild soap. To avoid discoloration of the material, we recommend against the use of chemical cleaners. The sheer fabric may also be ultrasonically cleaned. **Important: Do not clean the fabric using electrostatic wipes such as Swiffer® or Pledge Grab-It®.**

Policies & Warranties

Sheer Fabric

Knitted fabric may experience minor weave variations due to heat, humidity and other room conditions. These variations can result in light bowing, puckering and dimpling of the material. This is considered normal and does not constitute a failure in either workmanship or materials. The possible variations are minor and have been shown through case study, not to detract from the beauty of the product.

Limited Lifetime Warranty

The manufactured product is warranted against original defects in materials or workmanship for as long as the original purchaser owns the product provided that:

- The product was properly installed in a residential or commercial dwelling;
- The product was made or assembled exclusively from the original manufacturer's materials and components;
- The manufacturer's recommendations were followed regarding limitations and specifications.

This warranty extends only the original purchaser of the above stated products.

Obligations to the Consumer are limited to the repair or replacement of parts or products found to be defective. The manufacturer is not responsible for handling shipping charges or labor costs, for measuring and taking the product down.

If repairs are made under this warranty, the repairs will be made with like or similar parts.

Motorization Components and accessories have a five-year limited warranty. Batteries not included.

What the Warranty Does Not Cover

This warranty does not cover conditions or damages caused by abuse, accidents, alterations, misuse, or failure to follow instructions for measurement, installation, use, cleaning, or maintenance. Normal wear and tear, including but not limited to the items or occurrences below, is not covered by the warranty.

All fabrics can lose original intensity after long exposure to the sun. When left for extended periods in direct sunlight, plastics tend to yellow or crack over time. Some loss of color intensity or discoloration may occur in plastic materials or wood finishes when exposed to direct sunlight over long periods of time.

Colors may vary from lot to lot and may not exactly match samples of previous purchases.

The manufacturer considers these items or occurrences normal wear and tear, and they are not covered by this warranty.

THIS WARRANTY IS EXCLUSIVE AND IN LIEU OF ALL OTHER WRITTEN OR ORAL WARRANTIES OR OBLIGATIONS AND LIABILITIES. No person is authorized to extend or alter this warranty. The manufacturer SHALL HAVE NO LIABILITY WHATSOEVER FOR INCIDENTAL OR CONSEQUENTIAL DAMAGES. Some states do not allow the exclusion or limitation of incidental or consequential damages, so this limitation or exclusion may not apply to you. For Service Warranty claims: Please contact the original dealer for warranty assistance.

Conditions of Sale

All products are custom fabricated to your exact specifications. We cannot accept responsibility for errors in ordering or cancellations and changes after the order is in production.

Service and Repair

Service may be obtained by contacting our Customer Service Department. No products, parts, components or other materials will be authorized for return or repair without prior approval from the manufacturer. A Return Authorization (RA) may be obtained by contacting our Customer Service Department. In order to provide the quickest service possible, please have your Work Order number and original order information available when you call.